

2024

Comfortex
WINDOW FASHIONS

MDS
WINDOW FASHIONS

Midwest
Designer
Supply

1-888-523-2611



COMFOTEX CELLULAR SHADES

Manufacturer's Price List and Reference Guide

Effective April 21, 2024

Cord Lock & Cord Loop Operating Systems Discontinued



Detailed Table of Contents



Hardware



Photos



Price Grids



Videos



Product Specifications



Installation



General Information



Web



 Requires you to leave document

A.



Hardware Options



Size Standards



Hardware Options Pricing







Scotchgard™ Protection

Optional Scotchgard™ Protector is available with all Color Lux fabrics. Scotchgard™ keeps your shades looking newer, fresher and cleaner longer.



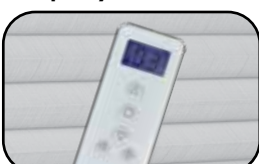

A combination of the latest advances in stain release and repellency provides exceptional stain protection. Spills wipe away easily and most dirt and stains lift out when cleaned.

Cellular Shade Collection
HARDWARE OPTIONS

	Key Features	Color Options	Hardware Size (Depth x Height)	Widths & Lengths*	More Information
Cordless Ultra 	<ul style="list-style-type: none"> • Child safe • No visible cords • Smooth & quiet operation • Sleek clear handle on rails • Two-On-One option available 	<ul style="list-style-type: none"> • Color Coordinated • Fabric Wrapped • Oil Rubbed Bronze 	2¼" x 1½"	Width: 18" up to 144" Length: 8" up to 84"	Page 48
Cordless Lift & Lock 	<ul style="list-style-type: none"> • Child safe • Easy push button operation • Rails lock securely in place in any position • Color coordinated rails and handle 	<ul style="list-style-type: none"> • Color Coordinated • Fabric Wrapped • Oil Rubbed Bronze 	Standard Head Rail: 1⅞" x ½" Deluxe Head Rail: 2⅝" x ½" Bottom Rail: 1⅞" x 1⅞"	Width: 16" up to 96" Length: 8" up to 84"	Page 50
12V Non-Rechargeable Simplicity Motorization 	<ul style="list-style-type: none"> • Raise & lower shade with click of a button • Great for large and hard to reach windows • Remote can operate multiple shades 	<ul style="list-style-type: none"> • Color Coordinated • Fabric Wrapped • Oil Rubbed Bronze 	2¼" x 1½"	Width: 18" to 108" Length: 8" to 120"	Page 52
7.4V Rechargeable Simplicity Motorization 	<ul style="list-style-type: none"> • Raise & lower shade with click of a button • Great for large and hard to reach windows • Remote can operate multiple shades • Standard or Top Down-Bottom Up 	<ul style="list-style-type: none"> • Color Coordinated • Fabric Wrapped • Oil Rubbed Bronze 	2¼" x 1½"	Width: 18" up to 108" Length: 8" up to 120"	Page 57
7.4V Rechargeable PowerTouch™ Cordless Wand 	<ul style="list-style-type: none"> • Raise & lower shade with push of a button • Just "Touch & Go" to operate the shade • Set your favorite shade position • Easy access to charging port on side of pendant 	<ul style="list-style-type: none"> • Wand and pendant available in white or black 	2¼" x 1½"	Width: 18" up to 144" Length: 8" up to 120"	Page 54

* Maximum widths and lengths listed do not take into account square foot or weight limitations. Make sure to refer to shaded areas on price groups for maximum size availability by fabric style.

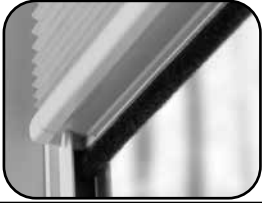
Cellular Shade Collection
HARDWARE OPTIONS

	Key Features	Color Options	Hardware Size (Depth x Height)	Widths & Lengths*	More Information
Ovation™ Slider 	<ul style="list-style-type: none"> Vertically oriented fabric glides across window Shade can stack left, right or center Great for sliding glass doors or room dividers 	<ul style="list-style-type: none"> White (Standard) Ivory Tan Gray 	3 5/8" x 1 3/4"	Width: 12" up to 168" Length: 24" up to 120"	Page 64
French Door Décor 	<ul style="list-style-type: none"> Great option for narrow windows and doors Available in non-moveable rails No Pull cords 	<ul style="list-style-type: none"> Color Coordinated Fabric Wrapped Oil Rubbed Bronze 	Standard Head Rail: 1 7/8" x 1/2" Deluxe Head Rail: 2 3/8" x 1/2"	Width: 6" up to 36" Length: 12" up to 96"	Page 82
Insulating SlumberShade™ 	<ul style="list-style-type: none"> Ultimate blackout shade Tracks keep out light, cold or heat Perfect for nurseries, day sleepers Available in Cordless and motorized 	<ul style="list-style-type: none"> Color Coordinated Fabric Wrapped Oil Rubbed Bronze Sidetracks are available in white, tan or Bronze 	Dependent on hardware choice	Width: 9" up to 96" Length: 8" up to 120"	Page 66
Top Down-Bottom Up 	<ul style="list-style-type: none"> Lower shade from top: raise from bottom Great for privacy Ideal for light control Available in Cordless and motorized 	<ul style="list-style-type: none"> Color Coordinated Fabric Wrapped Oil Rubbed Bronze 	Dependent on hardware choice	Width: 18" up to 120" Length: 8" up to 120"	See Product Availability Page 12
Two on One Head Rail 	<ul style="list-style-type: none"> Operate two shades on one rail Great for larger windows Individually operating shades 	<ul style="list-style-type: none"> Color Coordinated Fabric Wrapped Oil Rubbed Bronze 	Dependent on Style See Above	Width: 16" up to 144" Length: 8" up to 120"	See Product Availability Page 12

Maximum widths and lengths listed do not take into account square foot or weight limitations. Make sure to refer to shaded areas on price groups for maximum size availability by fabric style. Make sure to consult specification charts for specific fabric styles.

Cellular Shade Collection

FABRIC COLLECTIONS

Fabric Collection	Cell Size and Structure	Opacities	Fabric Content
Debut*	<ul style="list-style-type: none"> • ½-Inch Single Cell • ¾-Inch Single Cell • ½-Inch Double Cell 	<ul style="list-style-type: none"> • Light Filtering 	<ul style="list-style-type: none"> • Light Filtering: Non-Woven Polyester
Premiere**	<ul style="list-style-type: none"> • ½-Inch • ¾-Inch • Single Cell 	<ul style="list-style-type: none"> • Light Filtering • Blackout • Karma-Light Room Darkening 	<ul style="list-style-type: none"> • Light Filtering: Non-Woven Polyester • Blackout: Opaque lining pressed between two layers of non-woven polyester • Karma-Light technology insures color on front fabric will not be distorted like traditional blackout shades. Opaque lining is used only on back side of the cells • Limited Blackout colors available, refer to www.comfortex.com
Symphony	<ul style="list-style-type: none"> • ¾-Inch • Double Cell 	<ul style="list-style-type: none"> • Light Filtering • Flame Retardant Light Filtering • Blackout 	<ul style="list-style-type: none"> • Light Filtering: Non-Woven Polyester • Blackout: Non-Woven Polyester with foil lining

* Debut Light Filtering fabrics include solid colors, Homespun, Country Woven, Florance, Strata, Angel Hair, Blossom, Strie and Terrazzo.

** Premiere fabrics include the following prints: Spheres and Tuscan Scroll. Premiere Blackout fabrics include the following prints: Homespun, Country Woven, Florance, Strata, Angel Hair and Blossom.

Cellular Shade Collection

SIZE STANDARDS



Minimum				Cordless Ultra		Cordless Lift & Lock			
				Bottom Up	Top Down Bottom Up	Bottom Up	Top Down Bottom Up		
ALL FABRICS	Minimum Width			15" OB or 15 3/8" IB	18" OB or 18 3/8" IB	16" OB or 16 3/8" IB	20" OB or 20 3/8" IB		
	Min. Length			8"	8"	8"	8"		
Light Filtering	Price Group	Page			Bottom Up	Top Down Bottom Up	Bottom Up	Top Down Bottom Up	
Debut Premiere Symphony 3/8"	56 1 7	21-22 18 23	Maximum Width & Length			108" width 84" length	96" width 84" length	96" width 84" length	96" width 84" length
	Refer to shaded area in price grids for max size (sq ft) by fabric style								
Room Darkening & Blackout	Price Group	Page			Bottom Up	Top Down Bottom Up	Bottom Up	Top Down Bottom Up	
Premiere Symphony 3/8"	4 8	20 24	Maximum Width & Length			108" width 84" length	96" width 84" length	96" width 84" length	96" width 84" length
	Refer to shaded area in price grids for max size (sq ft) by fabric style							Not Available	84" width 84" length
						Bottom Up	Top Down Bottom Up	Bottom Up	Top Down Bottom Up
Stacking Heights Information On Page More Information On Page						Page 13 Page 48		Page 13 Page 50	

NOTE: Cordlock: Please Note: For any shades under 12" width, the maximum height is 80".
Cordloop and cordless shades less than 24" in width are limited to 84" in length
Maximum width for side mount refer to hardware pages.

Cellular Shade Collection

SIZE STANDARDS



				Motorization		Motorization	Two-On-One Head Rail
Minimum				Simplicity	Simplicity+ Rechargeable	PowerTouch Rechargeable	Cordless
ALL FABRICS				Min Width	18"	18"	36"
				Min. Length	8"	8"	8"
Light Filtering				Simplicity	Simplicity Rechargeable	PowerTouch Rechargeable	Cordless
Price Group	Page						
Debut	56	21-22	Maximum Width & Length	108" width 120" length**		108" width 120" length**	
Premiere	1	18				144" width 120" length++	
Symphony 3/8"	7	23		Refer to shaded area in price grids for max size (sq ft) by fabric style			
Room Darkening & Blackout				Simplicity	Simplicity Rechargeable	PowerTouch Rechargeable	Cordless
Price Group	Page						
Premiere	4	20	Maximum Width & Length	108" width 120" length**		108" width 120" length**	
				Refer to shaded area in price grids for max size (sq ft) by fabric style			
Symphony 3/8"	8	24		108" width 120" length**		108" width 120" length**	
				Simplicity	Simplicity Rechargeable	PowerTouch Rechargeable	Cordless
Stacking Heights Information On Page				Page 13		Page 13	
More Information On Page				Page 52		Page 62	
						Page 13 Page 12	

* Maximum widths and lengths listed do not take into account square foot or weight limitations. Make sure to refer to shaded areas on price groups for maximum size availability by fabric style. **Motorized shades less than 24" in width are limited to a maximum of 60" in length. +Simplicity Rechargeable Top Down-Bottom Up motorization minimum width is 24" IB and 23 3/8" OB. Cordless is 84" maximum length

Cellular Shade Collection

SIZE STANDARDS



		SlumberShade Cordless		Motorization
Minimum		Bottom Up	Top Down Bottom Up	Simplicity+ Rechargeable
ALL FABRICS	Minimum Width	16" IB	19"	19"
	Min. Length	8"	8"	8"

		SlumberShade Cordless		Motorization
Light Filtering		Bottom Up	Top Down Bottom Up	Simplicity+ Rechargeable
	Price Group			
	Page			
Debut	5-6	Maximum Width & Length	96" width 84" length	108" width 120" length
Premiere	3			
Symphony 3/8"	7			
		Refer to shaded area in price grids for max size (sq ft) by fabric style		

		SlumberShade Cordless		Motorization
Room Darkening & Blackout		Bottom Up	Top Down Bottom Up	Simplicity+ Rechargeable
	Price Group			
	Page			
Premiere	4	Maximum Width & Length	96" width 84" length	108" width 120" length
Symphony 3/8"	8			
		Refer to shaded area in price grids for max size (sq ft) by fabric style		
		Symphony Blackout not available as cordless		

		SlumberShade Cordless		Motorization
Stacking Heights Information On Page More Information On Page		Bottom Up	Top Down Bottom Up	Simplicity+ Rechargeable
		Page 13 Page 66	Page 13 Page 66	Page 13 Page 66

* Maximum widths and lengths listed do not take into account square foot or weight limitations. Make sure to refer to shaded areas on price groups for maximum size availability by fabric style.

** Motorized shades less than 24" in width are limited to a maximum of 60" in length.

+Simplicity Rechargeable Top Down-Bottom Up motorization minimum width is 25" IB and 24 3/8" OB. Cordless is 84" maximum length

Ovation Cellular Slider Shade SIZE STANDARDS



Ovation Cellular Slider		
Standard		
ALL FABRICS	Minimum Width	12"
	Minimum Length	24"

Light Filtering	Price Group	Page	Maximum Width & Length	Ovation Cellular Slider
Debut 1/2" Single Debut 1/2" Double	10	26	Maximum Width & Length	120"* x 108"
Symphony 3/8" Debut 3/4" Premiere 3/4"	10	26	Maximum Width & Length	168"* x 108"

Room Darkening & Blackout	Price Group	Page	Maximum Width & Length	Ovation Cellular Slider
Premiere 3/4"	11	27	Maximum Width & Length	168"* x 108"

Maximum Square Footage Side=100"
 Split=140"

Ovation Cellular Slider	
More Information On Page	Page 64

- * Split stack sliders are available in widths up to 240"; however, if the width exceeds 120", it will be fabricated as two separate sliders. The supplied valance will create the appearance of a single slider.
- ** Split stack sliders are available to 336", however if the width exceeds 168", the shade will be fabricated as two separate sliders. Supplied valance will create the appearance of a single slider. Please call customer service for assistance.
- *** Prelude split stack can go up to 190" wide on one head rail.

Speciality Shaped Shades

SIZE STANDARDS

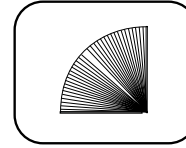
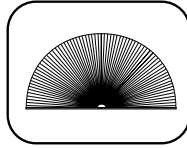

		Starburst Non-Movable Arch	Quarter Round Non-Movable
ALL FABRICS (except ¾" Prelude)	Minimum Width	18"	9"
	Minimum Length	9"	9"

Light Filtering	Price Group	Page		Starburst Non-Movable Arch	Quarter Round Non-Movable
Debut ½" Double	12	28	Maximum Width & Length	60" x 48"	48" x 48"
Debut ½" Single				60" x 48"	52" x 52"
Debut ¾"				60" x 48"	48" x 48"
Premiere ½"				60" x 48"	48" x 48"
Premiere ¾"				72" x 36"	48" x 48"
Symphony ¾"				96" x 48"	52" x 52"

Room Darkening & Blackout	Price Group	Page #		Starburst Non-Movable Arch	Quarter Round Non-Movable	
Premiere ½"	13	29	Maximum Width & Length	60" x 48"	48" x 48"	48" x 48"
Premiere ½"				60" x 48"	48" x 48"	48" x 48"
Premiere ¾"				72" x 36"	48" x 48"	48" x 48"
Symphony ¾"				96" x 48"	52" x 52"	48" x 48"
				Starburst Non-Movable Arch	Quarter Round Non-Movable	
More Information On Page				Page 68	Page 71	

NOTE: Starburst Movable Arches are available as inside mount only. Through our maximum width is 84" and our maximum is 72" on Sunset Arches, there are limitations on some larger sizes due to excessive weight. If the Sunset width exceeds 66", the maximum length is 60". If the Sunset width exceeds 72", the maximum length is 48".

Speciality Shaped Shades

SIZE STANDARDS

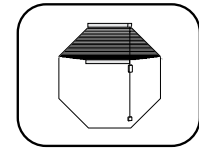
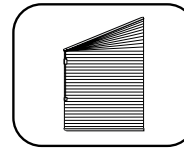

				Trapezoid	Octagon
ALL FABRICS (except 3/4" Prelude)	Minimum Width			12"	12"
	Minimum Length			12"	12"

Light Filtering	Price Group	Page		Price Group	Page	Trapezoid	Octagon	
Debut 1/2" Double	14	30	Maximum Width & Length		16	32	60" x 72"	48" x 48"
Debut 1/2" Single				60" x 72"			48" x 48"	
Debut 3/4"				60" x 72"			48" x 48"	
Premiere 1/2"				60" x 72"			48" x 48"	
Premiere 3/4"				48" x 72"			48" x 48"	
Symphony 3/8"				60" x 72"			48" x 48"	

Room Darkening & Blackout	Price Group	Page		Price Group	Page	Trapezoid	Octagon	
Premiere 1/2"	15	31	Maximum Width & Length		16	32	48" x 72"	48" x 48"
Premiere 3/4"				48" x 72"			48" x 48"	
Symphony 3/8"				60" x 72"			48" x 48"	

				Trapezoid	Octagon
More Information On Page				Page 73	Page 73

NOTE: Through our maximum width is 84" and our maximum is 72" on Sunset Arches, there are limitations on some larger sizes due to excessive weight.

*Max width of trapezoid refers to max width of the top rail.

Comfortex Skylight and Greenhouse Shades

SIZE STANDARDS

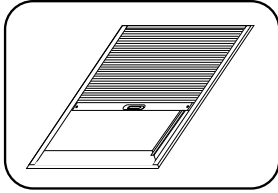

	Minimum	Balcony* 0°-15° 15°-75° 75°-90°**	Soprano*** Skylight/Greenhouse	Mezzo
ALL FABRICS	Min Width	15"	11"	18"
	Min Length	12"	11"	12"

Light Filtering	Price Group Page	Max Width & Length	Minimum					Price Group Page	Mezzo	Price Group Page
			Balcony* 0°-15°	15°-75°	75°-90°**	Soprano Skylight	Soprano Greenhouse+			
Debut ½" Double	Grid 20 Page 35	Max Width & Length	NA	NA	NA	NA	NA	Grid 18 Page 34	48" x 72"	Grid 22 Page 37
Debut ½" Single			36" x 96"	48" x 96"	48" x 72"	36" x 144"	29" x 180"		48" x 72"	
Debut ¾"			36" x 96"	48" x 96"	48" x 72"	48" x 72"	29" x 180"		48" x 72"	
Premiere ½"			NA	NA	NA	NA	NA		48" x 72"	
Premiere ¾"			36" x 96"	48" x 96"	48" x 72"	48" x 72"	36" x 180"		48" x 72"	
Symphony ¾"			36" x 96"	48" x 96"	48" x 72"	48" x 144"	36" x 180"		48" x 72"	

Room Darkening & Blackout	Price Group Page	Max Width & Length	Minimum					Price Group Page	Mezzo	Price Group Page
			Balcony* 0°-15°	15°-75°	75°-90°**	Soprano Skylight	Soprano Greenhouse+			
Premiere ½"	Grid 21 Page 36	Max Width & Length	NA	NA	NA	NA	NA	NA	48" x 72"	Grid 23 Page 38
Premiere ¾"			36" x 96"	48" x 96"	48" x 72"	48" x 72"	36" x 180"		48" x 72"	
Symphony ¾"			36" x 96"	48" x 96"	48" x 72"	NA	NA		48" x 72"	

More Information On Page	Page 77	Page 75	Page 79
--------------------------	---------	---------	---------

*Total Balcony shade area not to exceed 24 square feet. **Total Balcony shade area not to exceed 18 square feet. Balcony shades can be mounted on their side. Use vertical measurement as your width (max 36") and the horizontal measurement as your length (max 48"). ***Soprano Skylight minimum installation angle of 5 degrees. Maximum installation angle of 85 degrees. Horizontal (0 degrees) and vertical (90 degrees) applications are not recommended. +All Soprano Greenhouse shade orders require a completed and signed greenhouse shade order form. Orders must be faxed to Comfortex for processing. Download a copy of the order form at www.comfortex.com/comfortex-dealers.

Soprano Greenhouse shades are available in ¾" Symphony light filtering and Debut ½" light filtering only.

French Door Décor Shades

SIZE STANDARDS

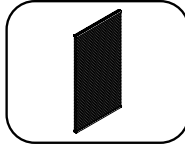

		Door Decor Non-Movable
ALL FABRICS	Minimum Width	6"
	Minimum Length	12"

Light Filtering	Price Group	Page		Door Decor Non-Movable
Debut 1/2" Single	24	39	Maximum Width & Length	36" x 96"
Debut 1/2" Double				36" x 96"
Debut 3/4"				36" x 96"
Premiere 1/2"				36" x 96"
Premiere 3/4"				36" x 96"
Symphony 3/8"				36" x 96"

Room Darkening & Blackout	Price Group	Page		Door Decor Non-Movable
Premiere 1/2"	26	41	Maximum Width & Length	36" x 96"
Premiere 3/4"				36" x 96"
Symphony 3/8"				36" x 96"

		Door Decor Non-Movable
More Information On Page		Page 82

Cellular Shade Collection

HARDWARE OPTION AVAILABILITY

Use this table to ensure your coordinating options and unique shapes are consistent with your product selections.

STANDARD CORD LOCK	Premiere 3/4" LF & RD	Symphony Light Filtering	Symphony Blackout	Debut 1/2" Light Filtering	Debut 3/4" Light Filtering	Debut Double Cell Light Filtering
--------------------	-----------------------------	--------------------------------	----------------------	----------------------------------	----------------------------------	--

Cord Lock Discontinued as of April 21, 2024

CORD LOOP						
-----------	--	--	--	--	--	--

Cord Loop Discontinued as of April 21, 2024

CORDLESS ULTRA						
Cordless Ultra	•	•	-	•	•	•
Cordless Two-On-One Head Rail	•	•	-	•	•	•
Cordless Ultra Top Down-Bottom Up	•	•	-	•	•	•

CORDLESS LIFT & LOCK						
Cordless Lift & Lock	•	•	•	•	•	•
Cordless Lift & Lock Two-On-One Head Rail	•	•	•	•	•	•
Cordless Lift & Lock Top Down-Bottom Up	•	•	•	•	•	•

MOTORIZATION						
Simplicity Motorization	•	•	•	•	•	•
Simplicity Rechargeable Motorization	•	•	•	•	•	•
PowerTouch™ Rechargeable	•	•	•	•	•	•
Top Down-Bottom Up	•	•	•	•	•	•

INSULATING SLUMBERSHADES						
Cordless Ultra	•	•	-	•	•	•
Cordless Ultra Top Down-Bottom Up	•	•	-	•	•	•
Simplicity Motorization	•	•	•	•	•	•
Simplicity Rechargeable Motorization	•	•	•	•	•	•

SKYLIGHTS AND SPECIALTY SHAPES						
Balcony Shading System	•	•	•	•	•	-
French Door Decor	•	•	•	•	•	•
Mezzo Motorized Skylights	•	•	•	•	•	•
Octagon	•	•	•	•	•	•
Ovation Cellular Slider	•••	•	-	•	•	•
Quarter Round - Non-Movable	•	•	•	•	•	•
Soprano Skylights	•	•	-	•	•	-
Soprano Greenhouses	-	•	-	•	-	-
Starburst Arch - Non-Movable	•	•	•	•	•	•
Trapezoid	•	•	•	•	•	•

••• 3/4" Premiere fabrics only

Cellular Shade Collection

SHADE STACK HEIGHTS

Measurements are in inches. Shade stacking heights applicable when the shade is in the fully raised position.

CORDLESS LIFT & LOCK - Includes head and bottom rails	48"	60"	72"	84"	108"	120"
Debut ½" Double Cell Light Filtering	2¼"	2¾"	2½"	2⅝"	2¾"	2⅞"
Debut ½" Single Cell Light Filtering	3"	3½"	3¾"	4⅛"	4⅝"	4¾"
Debut ¾" Single Cell Light Filtering	2¼"	2¾"	2½"	2⅝"	2¾"	2⅞"
Premiere ½" Single Cell Blackout	2¾"	3¼"	3⅝"	3⅝"	3⅞"	4"
Premiere ½" Single Cell Light Filtering	2⅝"	3¼"	3¼"	3⅝"	3½"	3½"
Premiere ¾" Single Cell Blackout	2¾"	3⅞"	3⅝"	3½"	3¾"	3⅞"
Premiere ¾" Single Cell Light Filtering	2¼"	2⅞"	3"	3⅞"	3⅞"	3½"
Symphony ¾" Double Cell Blackout	2¾"	3¼"	3½"	NA	NA	NA
Symphony ¾" Double Cell Light Filtering	3"	3½"	3¾"	4"	4¼"	4½"

For Top Down-Bottom Up, add 1¼"

OVATION	84"	96"	108"	120"
All Fabrics	6½"	7¼"	8"	8¾"

Ovations minimum fabric stack measures 6½" regardless of the ordered width. Fabric stacking dimensions are determined by the slider's hardware, not ordered width.

Cellular Shade Collection
SHADE STACK HEIGHTS

Cellular Shade Pricing Examples

Rechargeable Simplicity Pricing Example:

Debut 1/2"	
Light Filtering 42" x 60" Shade:	\$417.00
Simplicity Rechargeable Motor Surcharge:	\$300.00
Charger for Rechargeable:	\$30.00
14 Channel Remote Control:	\$50.00
Total List Price:	\$797.00

Motorized Top Down-Bottom Up Pricing Example:

Debut 1/2"	
Light Filtering 42" x 60" Shade:	\$417.00
Simplicity Rechargeable TDBU Surcharge:	\$515.00
Charger for Rechargeable:	\$30.00
TDBU Remote Control:	\$50.00
Total List Price:	\$1012.00

Cordless Ultra Simplicity Pricing Example:

Debut 1/2"	
Light Filtering 42" x 60" Shade:	\$417.00
Cordless Ultra Surcharge:	\$108.00
Scotchgard:	\$48.00
Total List Price:	\$573.00

Simplicity Motorization Pricing Example:

Debut 1/2"	
Light Filtering 42" x 60" Shade:	\$417.00
Simplicity Motor Surcharge:	\$300.00
14 Channel Remote Control:	\$50.00
Total List Price:	\$767.00

Cellular Shade Collection

HARDWARE UPGRADE OPTIONS

LIFT SYSTEM	UPGRADES	ADD
Cordless Lift & Lock	Bottom Up	No extra charge
	Top Down-Bottom Up	\$108
Cordless Ultra	Bottom Up	\$108
	Top Down-Bottom Up	\$215

DESIGNER UPGRADE OPTIONS	UPGRADES	ADD
Add to Any Lift System Upgrade <i>(Chart to the left)</i>	Metallic Hardware	\$30
	Fabric Wrapped Hardware	\$48
	Scotchgard Stain Protection <i>(Not available on Prelude)</i> <i>See Page 91 For More Information</i>	\$48
Slumbershade Light Blocking Sidetrack System	Insulating SlumberShades <i>See Page 66 For More Information</i>	\$174

ADDITIONAL OPTIONS	UPGRADES	ADD
Add to Any Upgrade Above	Two-On-One Head Rail	Price each panel as a separate shade, including lift system upgrades, add together, then add \$66
	Three-On-One Head Rail	Price each panel as a separate shade, including lift system upgrades, add together
	Cut Outs	\$69 Per side. See page 94 for more information
	Day-Night	Price each separate shade then add together
Other	Soprano - Two Moving Rails	\$169
	Ovation Center Stack	\$108
Accessories	3 Foot Expandable Pole - Silver	\$30
	5-10 Foot Expandable Pole - Black	\$54

Cellular Shade **Motorized** Hardware Upgrade Options

MOTORIZED	UPGRADES	ADD	
7.4V PowerTouch Rechargeable Motorization System	Rechargeable Integrated Battery Pack	\$100	For More Information Page 62
	Plug-In Charger for Rechargeable Li-Ion	\$30	
12V Simplicity Motorization System <i>(non-rechargeable)</i>	Motor and Battery Wand	\$300	For More Information Page 60
	48" Extension Wire	\$10	
	Single Unit DC Power Supply/Transformer	\$30	
7.4V Simplicity Rechargeable Motorization System	Motor and Integrated Battery Pack	\$300	For More Information Page 54
	Plug-In Charger for Rechargeable Li-Ion	\$30	
	Top Down-Bottom Up*	\$515	
	7.4v Solar Panel & Mounting Brackets	\$120	
Simplicity Systems Controllers	NEO Controller	\$280	For More Information Pages 61, 56 & 58
	NEO App for Mobile Devices	FREE	
	Simplicity 14 Channel White Remote **	\$50	
EZ Charge Extension Wand 7.4V Rechargeable Motors	Wall Mount Receiver Kit 7.4V	\$18	For More Information Page 59
	Extendable Wand 7.4V	\$32	
12V Low Voltage Hardwiring <i>(Not available on Prelude)</i>	9 Channel Wall Mount Transformer 12V	\$232	For More Information Page 60

*Upcharge includes motorization plus second motor and Top Down-Bottom Up components

** Simplicity 14 channel remote is TDBU capable and is required for Motorized Top Down-Bottom Up shades

Cellular Shade Collection

PRICING GRIDS



1 Cordless Lift & Lock
Premiere 1/2" Light Filtering



2 Cordless Lift & Lock
Premiere 1/2" Blackout



3 Cordless Lift & Lock
Premiere 3/4" Light Filtering



4 Cordless Lift & Lock
Premiere 3/4" Karma-Light
Room Darkening & Blackout



5 Cordless Lift & Lock
Debut 1/2" Single Cell



6 Cordless Lift & Lock
Debut 3/4" Single Cell
Debut 1/2" Double Cell



7 Cordless Lift & Lock
Symphony 3/8" Light Filtering



8 Cordless Lift & Lock
Symphony 3/8" Blackout



9 SlumberShade Fabric
Premiere 3/4" Blackout



10 Ovation Cellular Slider
Debut 1/2" | Debut 1/2" Double Cell
Debut 3/4" | Premiere 3/4"
Symphony 3/8" | Virtuoso 1/2"



11 Ovation Cellular Slider
Premiere 3/4" Blackout



12 Starburst Arches | Quarter Rounds
Light Filtering
Debut 1/2" Single Cell | Debut 1/2" Double Cell
Debut 3/4" Single Cell | Premiere 1/2" | Premiere 3/4"
Symphony 3/8" Double Cell



13 Starburst Arches | Quarter Rounds
Room Darkening & Blackout
Premiere 1/2" | Premiere 3/4"
Symphony 3/8" Double Cell



16 Trapezoids and Octagons Light Filtering
Debut 1/2" Single Cell | Debut 1/2" Double Cell
Debut 3/4" Single Cell | Premiere 1/2"
Premiere 3/4" | Symphony 3/8" Double Cell



17 Trapezoids and Octagons
Room Darkening & Blackout Fabrics
Premiere 1/2" | Premiere 3/4" | Symphony 3/8"



18 Soprano Skylights Light Filtering
Debut 1/2" Single Cell | Debut 3/4" Single Cell
Premiere 3/4" | Symphony 3/8" Double Cell



19 Soprano Skylights Room Darkening
Premiere 3/4"



20 Balcony Skylight Shading System
Light Filtering
Debut 1/2" Single Cell | Debut 3/4" Single Cell
Premiere 3/4" | Symphony 3/8" Double Cell

Cellular Shade Collection

PRICING GRIDS



21 Balcony Skylight Shading System
Blackout Fabrics
Premiere 3/4" | Symphony 3/8" Double Cell



22 Mezzo Motorized Skylights - White Rail
& Tracks Light Filtering
Debut 1/2" Single Cell | Debut 1/2" Double Cell
Debut 3/4" Single Cell | Premiere 1/2"
Premiere 3/4" | Symphony 3/8"



26 Non-Movable French Door Decor
Room Darkening & Blackout
Premiere 1/2" | Premiere 3/4" | Symphony 3/8"



23 Mezzo Motorized Skylights - White Rail
& Tracks Room Darkening & Blackout
Premiere 1/2" | Premiere 3/4" | Symphony 3/8"



24 Non-Movable French Door Decor
Light Filtering
Debut 1/2" Single Cell | Debut 1/2" Double Cell
Debut 3/4" Single Cell | Premiere 1/2" | Premiere 3/4"
| Symphony 3/8" Double Cell



**Cellular Shade Collection
HARDWARE UPGRADE OPTIONS**

Premiere 1/2" Light Filtering

**PRICE GROUP 1
Cordless Lift & Lock**

		Width In Inches											
		24	30	36	42	48	54	60	66	72	84	96	108
Length In Inches	36	216	239	276	305	338	368	398	426	456	524	586	654
	42	229	263	294	330	368	399	435	467	505	578	648	723
	48	242	280	321	357	398	434	472	511	552	642	735	825
	54	261	297	341	381	427	467	519	568	619	723	825	926
	60	277	321	368	409	454	519	577	630	690	803	917	1032
	66	292	338	387	443	506	568	630	695	758	882	1007	1133
	72	305	352	409	484	552	619	690	758	825	964	1099	1235
	78	321	376	450	524	597	671	746	820	894	1041	1190	1338
	84	329	405	484	564	642	723	803	882	964	1122	1281	1442
	90	345	432	519	605	690	774	861	946	1032	1204	1372	1543
	96	371	461	552	642	735	825	917	1007	1099	1281	1463	1645
	108	414	519	619	723	825	926	1032	1133	1235	1442	1645	1849
120	461	577	690	803	917	1032	1147	1257	1372	1600	1826	2057	

■ Cord Loop Hardware is recommended on sizes within the shaded area.
Motorized Lift Systems are not offered within the shaded area.

Premiere 1/2" Blackout

**PRICE GROUP 2
Cordless Lift & Lock**

		Width In Inches											
		24	30	36	42	48	54	60	66	72	84	96	108
Length In Inches	36	280	310	358	398	438	476	518	552	592	680	763	849
	42	298	342	381	429	476	518	567	607	656	751	844	942
	48	315	365	417	464	518	565	613	664	718	836	953	1073
	54	339	386	443	496	555	607	674	739	808	942	1073	1204
	60	359	415	476	532	589	674	749	819	895	1044	1191	1341
	66	376	438	505	577	658	739	819	904	983	1147	1309	1473
	72	398	457	532	630	718	808	895	983	1073	1253	1427	1606
	78	417	489	584	680	775	871	970	1066	1161	1354	1548	1741
	84	428	525	630	732	836	942	1044	1147	1253	1459	1666	1874
	90	448	562	674	786	895	1006	1118	1230	1341	1565	1784	2007
	96	482	601	718	836	953	1073	1191	1309	1427	1666	1902	2139
	108	539	674	808	942	1073	1204	1341	1473	1606	1874	2139	2404
120	601	749	895	1044	1191	1341	1490	1632	1784	2082	2374	2674	

■ Cord Loop Hardware is recommended on sizes within the shaded area.
Motorized Lift Systems are not offered within the shaded area.

DESIGNER UPGRADE OPTIONS (Add to any Lift System Upgrade On Page 15)		ADD
Metallic Hardware or Fabric Wrapped Hardware		\$30
Scotchgard Stain Protection (Not available on Prelude)		\$48
MOTORIZATION* OPTIONS		MORE INFO
For additional options and surcharges refer to page 15.		Pg 15
ADDITIONAL OPTIONS		MORE INFO
Prints & Custom Graphics		Add 20% - Includes Anna Cote, Gradients, Spheres, Tuscan Scroll and Custom Graphics
For additional options and surcharges refer to page 15.		Pg 15

*Motorized Pricing Examples pages 14, 53, 55 and 58

Cellular Shade Collection

PRICING

Premiere 3/4" Light Filtering

PRICE GROUP 3

Cordless Lift & Lock

		Width In Inches											
		24	30	36	42	48	54	60	66	72	84	96	108
Length In Inches	36	238	264	304	336	372	405	438	468	502	578	646	720
	42	252	291	323	363	405	439	481	514	556	637	715	797
	48	267	309	354	394	438	480	520	564	608	709	810	909
	54	287	327	376	422	469	514	571	627	683	797	909	1022
	60	305	352	405	451	501	571	636	694	759	885	1010	1137
	66	320	372	427	487	558	627	694	767	836	972	1111	1250
	72	336	388	451	534	608	683	759	836	909	1063	1211	1363
	78	354	414	494	578	658	740	822	905	985	1149	1312	1476
	84	362	445	534	621	709	797	885	972	1063	1237	1412	1592
	90	379	477	571	666	759	854	948	1043	1137	1326	1514	1703
	96	409	508	608	709	810	909	1010	1111	1211	1412	1613	1814
	108	456	571	683	797	909	1022	1137	1250	1363	1592	1814	2040
120	508	636	759	885	1010	1137	1265	1386	1514	1765	2014	2269	

 Cord Loop Hardware is recommended on sizes within the shaded area.

 Motorized Lift Systems are not offered within the shaded area.

LIFT SYSTEM AND DESIGN UPGRADES			ADD
Cordless Lift & Lock	Bottom Up		No Charge
	Top Down-Bottom Up		\$108
Cordless Ultra	Bottom Up		\$108
	Top Down-Bottom Up		\$215
DESIGNER UPGRADE OPTIONS (Add to any Lift System Upgrade Above)			ADD
Metallic Hardware			\$30
Fabric Wrapped Hardware			\$48
Scotchgard Stain Protection (Not available on Prelude)			\$48
MOTORIZATION*			MORE INFO
7.4V PowerTouch Rechargeable			Pg 62 \$100
12V Simplicity - Motor and Battery Wand			Pg 52 \$300
7.4V Simplicity Rechargeable Motorization - Motor with Integrated Battery			Pg 54 \$300
Plug-In Charger for Li-Ion Battery Pack (used for PowerTouch and Simplicity Rechargeable and is required)			Pg 54 \$30
Simplicity 14 Channel White Remote			Pg 58 \$50
Simplicity Smart Controller (NEO)			Pg 61 \$280
Top Down-Bottom Up Motorization and Solar Charge Option Pricing			Pg 15
7.4V EZ Charge Extension Wand	Wall Mount Receiver Kit 7.4V	\$18	For More Information Page 59
	Extendable Wand 7.4V	\$32	
12V Low Voltage Hardwiring (Not available on Prelude)	9 Channel Wall Mount Hardwired Transformer 12V	\$232	For More Information Page 60
ADDITIONAL OPTIONS		MORE INFO	
Prints & Custom Graphics		Add 20% - Includes Anna Cote, Gradients, Spheres, Tuscan Scroll and Custom Graphics	
For additional options and surcharges refer to page 15.		Pg 15	

*Motorized Pricing Examples pages 14, 53, 55 and 58



Cellular Shade Collection

PRICING

Premiere 3/4" Karma-Light Room Darkening & Blackout

PRICE GROUP 4 Cordless Lift & Lock

		Width In Inches											
		24	30	36	42	48	54	60	66	72	84	96	108
Length In Inches	36	309	343	396	437	483	525	568	607	653	749	841	933
	42	327	376	422	473	525	570	624	668	720	827	928	1035
	48	347	403	460	511	568	623	674	732	791	920	1051	1179
	54	373	423	488	547	609	668	741	814	887	1035	1179	1326
	60	398	457	525	585	648	741	825	900	983	1148	1312	1475
	66	415	483	555	634	723	814	900	995	1083	1262	1442	1623
	72	437	505	585	693	791	887	983	1083	1179	1380	1571	1768
	78	460	539	642	749	853	959	1067	1174	1279	1490	1702	1915
	84	472	578	693	808	920	1035	1148	1262	1380	1605	1832	2063
	90	493	619	741	866	983	1108	1231	1353	1475	1720	1963	2207
	96	530	660	791	920	1051	1179	1312	1442	1571	1832	2091	2352
	108	592	741	887	1035	1179	1326	1475	1623	1768	2063	2352	2644
120	660	825	983	1148	1312	1475	1640	1797	1963	2291	2610	2942	

 Cord Loop Hardware is recommended on sizes within the shaded area.
 Motorized Lift Systems are not offered within the shaded area.

LIFT SYSTEM AND DESIGN UPGRADES			ADD
Cordless Lift & Lock	Bottom Up		No Charge
	Top Down-Bottom Up		\$108
Cordless Ultra	Bottom Up		\$108
	Top Down-Bottom Up		\$215
DESIGNER UPGRADE OPTIONS (Add to any Lift System Upgrade Above)			ADD
Metallic Hardware			\$30
Fabric Wrapped Hardware			\$48
Scotchgard Stain Protection (Not available on Prelude)			\$48
MOTORIZATION*			MORE INFO
7.4V PowerTouch Rechargeable			Pg 62 \$100
12V Simplicity - Motor and Battery Wand			Pg 52 \$300
7.4V Simplicity Rechargeable Motorization - Motor with Integrated Battery			Pg 54 \$300
Plug-In Charger for Li-Ion Battery Pack (used for PowerTouch and Simplicity Rechargeable and is required)			Pg 56 \$30
Simplicity 14 Channel White Remote			Pg 58 \$50
Simplicity Smart Controller (NEO)			Pg 61 \$280
Top Down-Bottom Up Motorization and Solar Charge Option Pricing			Pg 57
7.4V EZ Charge Extension Wand	Wall Mount Receiver Kit 7.4V	\$18	For More Information Page 59
	Extendable Wand 7.4V	\$32	
12V Low Voltage Hardwiring (Not available on Prelude)	9 Channel Wall Mount Hardwired Transformer 12V	\$232	For More Information Page 60
ADDITIONAL OPTIONS		MORE INFO	
Prints & Custom Graphics		Add 20% - Includes Anna Cote, Gradients, Spheres, Tuscan Scroll and Custom Graphics	
For additional options and surcharges refer to page 15.		Pg 15	

*Motorized Pricing Examples pages 14, 53, 55 and 58

Cellular Shade Collection
PRICING

Debut 1/2" Single Cell

PRICE GROUP 5
Cordless Lift & Lock

		Width In Inches											
		24	30	36	42	48	54	60	66	72	84	96	108
Length In Inches	36	205	229	263	292	322	351	380	405	434	501	561	623
	42	219	251	280	316	351	381	417	447	481	552	619	691
	48	232	268	306	342	380	415	451	488	527	614	700	788
	54	250	283	325	365	406	447	496	542	592	691	788	886
	60	264	305	351	390	434	496	551	601	658	767	874	983
	66	277	322	371	423	483	542	601	664	723	842	963	1082
	72	292	336	390	463	527	592	658	723	788	920	1049	1179
	78	306	359	429	501	569	641	713	782	853	995	1136	1278
	84	315	386	463	538	614	691	767	842	920	1071	1224	1378
	90	329	413	496	578	658	739	821	903	983	1149	1310	1474
	96	354	439	527	614	700	788	874	963	1049	1224	1397	1570
108	397	496	592	691	788	886	983	1082	1179	1378	1570	1766	
120	439	551	658	767	874	983	1095	1200	1310	1528	1744	1963	

LIFT SYSTEM AND DESIGN UPGRADES			ADD
Cordless Lift & Lock	Bottom Up		No Charge
	Top Down-Bottom Up		\$108
Cordless Ultra	Bottom Up		\$108
	Top Down-Bottom Up		\$215
DESIGNER UPGRADE OPTIONS (Add to any Lift System Upgrade Above)			ADD
Metallic Hardware			\$30
Fabric Wrapped Hardware			\$48
Scotchgard Stain Protection <i>(Not available on Prelude)</i>			\$48
MOTORIZATION*			MORE INFO
7.4V PowerTouch Rechargeable			Pg 62 \$100
12V Simplicity - Motor and Battery Wand			Pg 52 \$300
7.4V Simplicity Rechargeable Motorization - Motor with Integrated Battery			Pg 54 \$300
Plug-In Charger for Li-Ion Battery Pack (used for PowerTouch and Simplicity Rechargeable and is required)			Pg 56 \$30
Simplicity 14 Channel White Remote			Pg 58 \$50
Simplicity Smart Controller (NEO)			Pg 61 \$280
Top Down-Bottom Up Motorization and Solar Charge Option Pricing			Pg 57
7.4V EZ Charge Extension Wand	Wall Mount Receiver Kit 7.4V	\$18	For More Information Page 59
	Extendable Wand 7.4V	\$32	
12V Low Voltage Hardwiring <i>(Not available on Prelude)</i>	9 Channel Wall Mount Hardwired Transformer 12V	\$232	For More Information Page 60
ADDITIONAL OPTIONS			MORE INFO
Prints & Custom Graphics			Add 20% - Includes Anna Cote, Gradients, Spheres, Tuscan Scroll and Custom Graphics
For additional options and surcharges refer to page 15.			Pg 15

*Motorized Pricing Examples pages 14, 53, 55 and 58

Cellular Shade Collection
PRICING

Debut 3/4" Single Cell
Debut 1/2" Double Cell

PRICE GROUP 6
Cordless Lift & Lock

		Width In Inches											
		24	30	36	42	48	54	60	66	72	84	96	108
Length In Inches	36	226	252	292	321	355	385	418	447	480	551	618	685
	42	241	277	310	348	385	420	458	492	528	607	681	761
	48	255	296	338	376	418	457	496	538	581	676	770	867
	54	276	312	357	401	448	492	547	597	653	761	867	975
	60	292	336	385	430	477	547	607	661	723	844	964	1082
	66	305	355	408	465	532	597	661	732	796	926	1059	1190
	72	321	371	430	509	581	653	723	796	867	1011	1154	1296
	78	338	397	472	551	627	706	785	862	940	1095	1250	1405
	84	347	426	509	592	676	761	844	926	1011	1178	1345	1516
	90	362	454	547	636	723	814	904	994	1082	1264	1442	1623
	96	389	484	581	676	770	867	964	1059	1154	1345	1536	1727
	108	435	547	653	761	867	975	1082	1190	1296	1516	1727	1943
120	484	607	723	844	964	1082	1205	1320	1442	1682	1918	2161	

LIFT SYSTEM AND DESIGN UPGRADES			ADD	
Cordless Lift & Lock	Bottom Up		No Charge	
	Top Down-Bottom Up		\$108	
Cordless Ultra	Bottom Up		\$108	
	Top Down-Bottom Up		\$215	
DESIGNER UPGRADE OPTIONS (Add to any Lift System Upgrade Above)			ADD	
Metallic Hardware			\$30	
Fabric Wrapped Hardware			\$48	
Scotchgard Stain Protection (Not available on Prelude)			\$48	
MOTORIZATION*			MORE INFO	ADD
7.4V PowerTouch Rechargeable			Pg 62	\$100
12V Simplicity - Motor and Battery Wand			Pg 52	\$300
7.4V Simplicity Rechargeable Motorization - Motor with Integrated Battery			Pg 54	\$300
Plug-In Charger for Li-Ion Battery Pack (used for PowerTouch and Simplicity Rechargeable and is required)			Pg 56	\$30
Simplicity 14 Channel White Remote			Pg 58	\$50
Simplicity Smart Controller (NEO)			Pg 61	\$280
Top Down-Bottom Up Motorization and Solar Charge Option Pricing			Pg 57	
7.4V EZ Charge Extension Wand	Wall Mount Receiver Kit 7.4V	\$18	For More Information Page 59	
	Extendable Wand 7.4V	\$32		
12V Low Voltage Hardwiring (Not available on Prelude)	9 Channel Wall Mount Hardwired Transformer 12V	\$232	For More Information Page 60	
ADDITIONAL OPTIONS			MORE INFO	
Prints & Custom Graphics			Add 20% - Includes Anna Cote, Gradients, Spheres, Tuscan Scroll and Custom Graphics	
For additional options and surcharges refer to page 15.			Pg 15	

*Motorized Pricing Examples pages 14, 53, 55 and 58

Cellular Shade Collection
PRICING

Symphony 3/8" Light Filtering

PRICE GROUP 7
Cordless Lift & Lock

		Width In Inches											
		24	30	36	42	48	54	60	66	72	84	96	108
Length In Inches	36	196	218	250	277	306	333	360	386	414	476	534	594
	42	208	238	267	300	333	362	397	426	457	525	589	658
	48	220	255	292	325	360	396	429	464	502	584	667	749
	54	238	270	310	347	387	426	472	518	564	658	749	842
	60	251	292	333	372	413	472	524	571	626	731	833	937
	66	263	306	352	403	460	518	571	632	690	801	916	1029
	72	277	321	372	439	502	564	626	690	749	874	999	1124
	78	292	342	408	476	542	610	678	744	812	946	1082	1216
	84	299	368	439	511	584	658	731	801	874	1020	1163	1310
	90	313	393	472	549	626	703	781	860	937	1094	1248	1403
	96	336	418	502	584	667	749	833	916	999	1163	1329	1494
	108	376	472	564	658	749	842	937	1029	1124	1310	1494	1682
120	418	524	626	731	833	937	1041	1142	1248	1456	1660	1870	

 Cord Loop Hardware is recommended on sizes within the shaded area.
Motorized Lift Systems are not offered within the shaded area.

FABRIC SURCHARGES		ADD	
Prints and Duotones		20%	
Flame Resistant 3/8" double cell		30%	
Flame Resistant 3/4" single cell		30%	
LIFT SYSTEM AND DESIGN UPGRADES		ADD	
Cordless Lift & Lock	Bottom Up	No Charge	
	Top Down-Bottom Up	\$108	
Cordless Ultra	Bottom Up	\$108	
	Top Down-Bottom Up	\$215	
DESIGNER UPGRADE OPTIONS (Add to any Lift System Upgrade Above)		ADD	
Metallic Hardware		\$30	
Fabric Wrapped Hardware		\$48	
Scotchgard Stain Protection (Not available on Prelude)		\$48	
MOTORIZATION*		MORE INFO	ADD
7.4V PowerTouch Rechargeable		Pg 62	\$100
12V Simplicity - Motor and Battery Wand		Pg 52	\$300
7.4V Simplicity Rechargeable Motorization - Motor with Integrated Battery		Pg 54	\$300
Plug-In Charger for Li-Ion Battery Pack (used for PowerTouch and Simplicity Rechargeable and is required)		Pg 56	\$30
Simplicity 14 Channel White Remote		Pg 58	\$50
Simplicity Smart Controller (NEO)		Pg 61	\$280
Top Down-Bottom Up Motorization and Solar Charge Option Pricing		Pg 57	
7.4V EZ Charge Extension Wand	Wall Mount Receiver Kit 7.4V		\$18
	Extendable Wand 7.4V		\$32
12V Low Voltage Hardwiring (Not available on Prelude)	9 Channel Wall Mount Hardwired Transformer 12V		\$232
ADDITIONAL OPTIONS		MORE INFO	
For additional options and surcharges refer to page 15.			Pg 15

*Motorized Pricing Examples pages 14, 53, 55 and 58

Cellular Shade Collection
PRICING

Symphony 3/8" Blackout

PRICE GROUP 8
Cordless Lift & Lock

		Width In Inches												
		24	30	36	42	48	54	60	66	72	84	96	108	120
Length In Inches	36	254	281	325	359	399	432	471	502	539	618	693	770	852
	42	271	310	347	389	432	472	514	552	595	681	766	854	948
	48	285	331	377	423	471	512	557	605	653	760	867	975	1082
	54	309	351	403	451	505	552	613	672	732	854	975	1095	1217
	60	327	376	432	483	538	613	680	744	814	948	1082	1217	1354
	66	342	399	457	524	597	672	744	821	895	1042	1190	1338	1487
	72	359	415	483	571	653	732	814	895	975	1138	1296	1460	1623
	78	377	445	530	618	706	793	881	967	1055	1231	1405	1581	1757
	84	388	476	571	664	760	854	948	1042	1138	1326	1515	1703	1891
	90	406	510	613	714	814	915	1017	1116	1217	1421	1623	1824	2027
	96	437	543	653	760	867	975	1082	1190	1296	1515	1728	1943	2161
	108	489	613	732	854	975	1095	1217	1338	1460	1703	1943	2186	2430
120	543	680	814	948	1082	1217	1354	1485	1623	1891	2158	2430	2700	

 Cord Loop Hardware is recommended on sizes within the shaded area.
Motorized Lift Systems are not offered within the shaded area.

LIFT SYSTEM AND DESIGN UPGRADES			ADD
Cordless Lift & Lock	Bottom Up		No Charge
	Top Down-Bottom Up		\$108
Cordless Ultra	Bottom Up		NA
	Top Down-Bottom Up		NA
DESIGNER UPGRADE OPTIONS (Add to any Lift System Upgrade Above)			ADD
Metallic Hardware			\$30
Fabric Wrapped Hardware			\$48
Scotchgard Stain Protection (Not available on Prelude)			\$48
MOTORIZATION*			MORE INFO
			ADD
7.4V PowerTouch Rechargeable			Pg 62 \$100
12V Simplicity - Motor and Battery Wand			Pg 52 \$300
7.4V Simplicity Rechargeable Motorization - Motor with Integrated Battery			Pg 54 \$300
Plug-In Charger for Li-Ion Battery Pack (used for PowerTouch and Simplicity Rechargeable and is required)			Pg 56 \$30
Simplicity 14 Channel White Remote			Pg 58 \$50
Simplicity Smart Controller (NEO)			Pg 61 \$280
Top Down-Bottom Up Motorization and Solar Charge Option Pricing			Pg 57
7.4V EZ Charge Extension Wand	Wall Mount Receiver Kit 7.4V	\$18	For More Information Page 59
	Extendable Wand 7.4V	\$32	
12V Low Voltage Hardwiring (Not available on Prelude)	9 Channel Wall Mount Hardwired Transformer 12V	\$232	For More Information Page 60
ADDITIONAL OPTIONS			MORE INFO
For additional options and surcharges refer to page 83.			Pg 83

*Motorized Pricing Examples pages 14, 53, 55 and 58

**Cellular Shade Collection
PRICING**

This fabric is best for Room Darkening SlumberShades.

**SlumberShade Fabric
Premiere 3/4" Blackout**

**PRICE GROUP 9
SlumberShade Fabric**

Price grid is for shades only. SlumberShade Tracks are a separate charge - See below.

		Width In Inches											
		24	30	36	42	48	54	60	66	72	84	96	108
Length In Inches	36	309	343	396	437	483	525	568	607	653	749	841	933
	42	327	376	422	473	525	570	624	668	720	827	928	1035
	48	347	403	460	511	568	623	674	732	791	920	1051	1179
	54	373	423	488	547	609	668	741	814	887	1035	1179	1326
	60	398	457	525	585	648	741	825	900	983	1148	1312	1475
	66	415	483	555	634	723	814	900	995	1083	1262	1442	1623
	72	437	505	585	693	791	887	983	1083	1179	1380	1571	1768
	78	460	539	642	749	853	959	1067	1174	1279	1490	1702	1915
	84	472	578	693	808	920	1035	1148	1262	1380	1605	1832	2063
	90	493	619	741	866	983	1108	1231	1353	1475	1720	1963	2207
	96	530	660	791	920	1051	1179	1312	1442	1571	1832	2091	2352
	108	592	741	887	1035	1179	1326	1475	1623	1768	2063	2352	2644
120	660	825	983	1148	1312	1475	1640	1797	1963	2291	2610	2942	

 Cord Loop Hardware is recommended on sizes within the shaded area. Motorized Lift Systems are not offered within the shaded area.

LIFT SYSTEM AND DESIGN UPGRADES			ADD
Cordless Lift & Lock	Bottom Up		No Charge
	Top Down-Bottom Up		\$108
Cordless Ultra	Bottom Up		\$108
	Top Down-Bottom Up		\$215
DESIGNER UPGRADE OPTIONS (Add to any Lift System Upgrade Above)			ADD
Metallic Hardware			\$30
Fabric Wrapped Hardware			\$48
Scotchgard Stain Protection (Not available on Prelude)			\$48
MOTORIZATION*			MORE INFO
7.4V PowerTouch Rechargeable			Pg 62 \$100
12V Simplicity - Motor and Battery Wand			Pg 52 \$300
7.4V Simplicity Rechargeable Motorization - Motor with Integrated Battery			Pg 54 \$300
Plug-In Charger for Li-Ion Battery Pack (used for PowerTouch and Simplicity Rechargeable and is required)			Pg 56 \$30
Simplicity 14 Channel White Remote			Pg 58 \$50
Simplicity Smart Controller (NEO)			Pg 61 \$280
Top Down-Bottom Up Motorization and Solar Charge Option Pricing			Pg 57
7.4V EZ Charge Extension Wand	Wall Mount Receiver Kit 7.4V	\$18	For More Information Page 59
	Extendable Wand 7.4V	\$32	
12V Low Voltage Hardwiring (Not available on Prelude)	9 Channel Wall Mount Hardwired Transformer 12V	\$232	For More Information Page 60
ADDITIONAL OPTIONS			ADD
Slumbershade Light Blocking Sidetrack System See page 66 for more information.			\$174

*Motorized Pricing Examples pages 14, 53, 55 and 58

Ovation Cellular Slider Shade

PRICING

LIGHT FILTERING FABRICS

Debut 1/2" Premiere 3/4"
 Debut 1/2" Double Cell Symphony 3/8"
 Debut 3/4" Virtuoso 1/2"

PRICE GROUP 10

Ovation Cellular Slider

		Width In Inches																	
		24	30	36	42	48	54	60	66	72	78	84	96	108	120	132	144	156	168
Length In Inches	36	690	748	814	873	924	987	1049	1103	1163	1231	1284	1388	1493	1606	1715	1827	1941	2053
	42	733	804	874	946	1003	1071	1144	1206	1279	1344	1403	1525	1643	1778	1906	2036	2167	2299
	48	781	852	941	1016	1082	1154	1234	1312	1386	1451	1528	1672	1797	1943	2087	2230	2372	2518
	54	824	912	999	1083	1155	1237	1318	1409	1493	1571	1654	1808	1954	2111	2271	2427	2590	2747
	60	870	964	1057	1151	1234	1323	1415	1510	1598	1686	1775	1944	2107	2277	2455	2627	2800	2979
	66	920	1020	1122	1219	1312	1409	1502	1615	1706	1808	1889	2087	2259	2447	2628	2815	3000	3186
	72	970	1074	1183	1293	1397	1494	1597	1714	1819	1924	2016	2233	2410	2619	2826	3038	3246	3454
	78	1020	1133	1249	1368	1476	1585	1692	1820	1927	2037	2138	2364	2563	2785	3003	3225	3447	3668
	84	1071	1189	1310	1443	1559	1672	1787	1922	2037	2158	2263	2505	2716	2948	3186	3420	3651	3884
	90	1116	1243	1380	1517	1631	1760	1885	2028	2150	2274	2393	2648	2866	3124	3383	3642	3901	4161
96	1162	1300	1444	1588	1712	1840	1986	2131	2263	2396	2515	2790	3024	3288	3555	3822	4090	4353	
108	1208	1350	1506	1660	1789	1927	2081	2228	2372	2515	2640	2932	3179	3454	3726	4001	4272	4545	
114	1270	1417	1585	1743	1879	2023	2197	2348	2497	2652	2782	3092	3353	3635	3902	4176	4446	4720	
120	1333	1489	1668	1827	1971	2121	2305	2462	2625	2789	2924	3250	3526	3816	4097	4377	4660	4940	

PRODUCT INFORMATION

See Page 64 for detailed information.

DESIGN UPGRADES

Left or Right Stack	Included, specify when ordering
Center Stack	Add \$108
Split Stack*	Price by dividing the full width measurement in half. Price as two separate units and add together.
Dual Panel**	Price as two separate units and add together.

FABRIC SURCHARGES

	ADD
Prints and Duotones	Add 20%
Flame Resistant 3/8" Double Cell	Add 30%
Flame Resistant 3/4" Single Cell	Add 30%

* Split stack sliders are available in widths up to 240". If the width exceeds 120", it will be fabricated as two separate sliders. The supplied valance will create the appearance of a single slider.

** A Dual Panel Stack Slider has a center opening design with a different fabric on each side, each of which can span the full width of the window. Both panels will be of equal width unless otherwise specified.

Ovation Cellular Slider Shade

PRICING

ROOM DARKENING & BLACKOUT FABRICS

Premiere 3/4" Blackout

PRICE GROUP 11

Ovation Cellular Slider

		Width In Inches																	
		24	30	36	42	48	54	60	66	72	78	84	96	108	120	132	144	156	168
Length In Inches	36	898	971	1057	1134	1201	1283	1364	1434	1515	1600	1669	1804	1941	2087	2229	2376	2525	2668
	42	952	1046	1138	1230	1304	1391	1487	1568	1663	1748	1824	1983	2135	2310	2478	2646	2818	2989
	48	1017	1108	1224	1319	1409	1500	1605	1706	1802	1886	1987	2173	2337	2526	2713	2899	3083	3273
	54	1071	1185	1296	1409	1501	1611	1712	1832	1941	2042	2150	2351	2539	2743	2952	3156	3367	3571
	60	1130	1253	1374	1494	1605	1720	1837	1963	2078	2191	2307	2527	2739	2961	3191	3414	3639	3874
	66	1196	1326	1459	1586	1706	1830	1954	2099	2218	2351	2455	2713	2936	3181	3417	3659	3900	4141
	72	1262	1397	1538	1683	1819	1943	2077	2228	2363	2501	2622	2901	3133	3405	3673	3949	4220	4488
	78	1326	1473	1623	1778	1919	2061	2200	2366	2504	2650	2779	3074	3330	3619	3906	4191	4483	4768
	84	1391	1546	1703	1877	2027	2173	2324	2497	2650	2804	2942	3257	3531	3833	4141	4446	4748	5050
	90	1451	1617	1794	1971	2122	2287	2452	2635	2794	2954	3110	3442	3727	4061	4398	4733	5072	5407
	96	1512	1689	1878	2063	2225	2393	2581	2770	2942	3115	3270	3627	3931	4275	4621	4968	5319	5660
108	1571	1753	1958	2158	2325	2504	2705	2896	3082	3270	3432	3814	4132	4490	4844	5199	5554	5906	
114	1652	1841	2061	2265	2444	2629	2856	3050	3246	3446	3617	4019	4361	4726	5074	5428	5779	6135	
120	1732	1935	2167	2376	2563	2757	2998	3200	3412	3626	3801	4225	4583	4959	5327	5691	6057	6422	

PRODUCT INFORMATION

See Page 64 for detailed information.

DESIGN UPGRADES

Left or Right Stack	Included, specify when ordering
Center Stack	Add \$108
Split Stack*	Price by dividing the full width measurement in half. Price as two separate units and add together.
Dual Panel**	Price as two separate units and add together.

FABRIC SURCHARGES

	ADD
Prints and Duotones	Add 20%
Flame Resistant 3/8" Double Cell	Add 30%
Flame Resistant 3/4" Single Cell	Add 30%

* Split stack sliders are available in widths up to 240". If the width exceeds 120", it will be fabricated as two separate sliders. The supplied valance will create the appearance of a single slider.

** A Dual Panel Stack Slider has a center opening design with a different fabric on each side, each of which can span the full width of the window. Both panels will be of equal width unless otherwise specified.

Speciality Shaped Shades
PRICING

LIGHT FILTERING FABRICS

Debut 1/2" Single Cell
 Debut 1/2" Double Cell
 Debut 3/4" Single Cell
 Premiere 1/2"

Premiere 3/4"
 Symphony 3/8" Double Cell

PRICE GROUP 12
Starburst Arches
Quarter Rounds

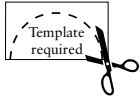

For widths wider than 58"

		Width In Inches												
		24	30	36	42	48	54	60	66	72	78	84	90	96
Length In Inches	Non-Movable Starburst	373	423	481	547	655	749	845	952	1074	1200	1333	1477	1643
	Non-Movable Quarter Rounds	481	547	623	710	808	917							

Product Information: All fabrics are not available in all widths, lengths and hardware options. Refer to Size Specifications on page 8 and 9 for availability. See pages 68 and 71-72 for detailed information. Templates required on non-perfect non-movable Starburst Arches and Quarter Rounds.

FABRIC SURCHARGES		ADD
Scotchgard Stain Protector (Not available on Prelude)		\$48
Debut 1/2" Single Cell Print Fabric	Includes: Homespun, Country Woven, Florance, Strata, Angel Hair, Blossom, Terrazzo and Strie	20%
Debut 1/2" Double Cell Print Fabric Debut 3/4" Single Cell Print Fabric	Includes: Homespun, Country Woven, Florance, Strata and Angel Hair	20%
Premiere Fabric	Includes: Homespun, Country Woven, Florance, Spheres, Strata, Tuscan Scroll, Angel Hair, Blossom, and Gradients	20%
Symphony Fabric	Symphony Prints and Duotones	20%
	Symphony Double Cell Flame Resistant	30%
PRICING INFORMATION		
Starburst Arches	Price according to the largest radius measurement. If the height is greater than the width, take height X 2 and use that number to determine pricing. Metallic rails available.	
Quarter Rounds	Price according to the largest radius measurement.	
HARDWARE UPGRADE SURCHARGES* AND ACCESSORIES		ADD
5-10 Foot Expandable Pole - Black		\$54

Speciality Shaped Shades PRICING

ROOM DARKENING & BLACKOUT FABRICS

Premiere 1/2"
 Premiere 3/4"

Symphony 3/8" Double Cell

PRICE GROUP 13 Starburst Arches Quarter Round

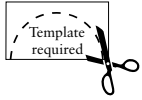

For widths wider than 58"

Length In Inches	Width In Inches												
	24	30	36	42	48	54	60	66	72	78	84	90	96
Non-Movable Starburst	484	551	624	710	850	975	1097	1238	1397	1560	1732	1922	2135
Non-Movable Quarter Rounds	624	710	810	922	1049	1191							

Product Information: All fabrics are not available in all widths, lengths and hardware options. Refer to Size Specifications on page 8 and 9 for availability. See pages 68 and 71-72 for detailed information. Templates required on non-perfect non-movable Starburst Arches and Quarter Rounds.

FABRIC SURCHARGES		ADD
Scotchgard Stain Protector (Not available on Prelude)		\$48
Premiere Fabric Prints	Includes: Honespun, Country Woven, Florance, Spheres, Strata, Tuscan Scroll, Angel Hair, Blossom, and Gradients	20%
PRICING INFORMATION		
Starburst Arches	Price according to the largest radius measurement. If the height is greater than the width, take height X 2 and use that number to determine pricing. Metallic rails available.	
Quarter Rounds	Price according to the largest radius measurement.	
HARDWARE UPGRADE SURCHARGES* AND ACCESSORIES		ADD
5-10 Foot Expandable Pole - Black		\$54

Please note: On the Stationary Starburst Arches when the fabric wrapped hardware is selected, the fabric wrap will be spliced in the center of the base rail.

LIGHT FILTERING

PRICE GROUP 14
Sunset Movable Arches



Not Offered as of April 21, 2024

ROOM DARKENING & BLACKOUT FABRICS

PRICE GROUP 15
Sunset Movable Arches

Not Offered as of April 21, 2024

Speciality Shaped Shades

PRICING

LIGHT FILTERING

Debut 1/2" Single Cell
 Debut 1/2" Double Cell
 Debut 3/4" Single Cell

Premiere 1/2"
 Premiere 3/4"
 Symphony 3/8" Double Cell

PRICE GROUP 16

Trapezoids and Octagons

		Width In Inches						
		24	30	36	42	48	54	60
Length In Inches	36	664	703	752	806	852	896	941
	42	690	735	788	845	896	946	1001
	48	709	763	827	886	941	998	1058
	54	733	791	860	922	986	1051	1112
	60	758	823	895	963	1028	1106	1172
	66	782	852	931	1003	1079	1155	1225
	72	806	877	963	1046	1125	1206	1289

All fabrics are not available in all widths, lengths and applications. Refer to Size Specifications on page 9 for availability.

Product Information: See pages 73-74 for detailed information. Width, length and one side are required measurements for Octagon Shades. **Trapezoid orders must be emailed in with a diagram that includes the measurements for 4 sides.** No templates are required for Trapezoid Shades. * Virtuoso fabrics are available as Octagons only. Max width of trapezoid is 60", this refers to full width of top rail.

FABRIC SURCHARGES		ADD
Scotchgard Stain Protector (Not available on Prelude)		\$48
Debut 1/2" Single Cell Print Fabric	Includes: Homespun, Country Woven, Florance, Strata, Angel Hair, Blossom, Terrazzo and Strie	20%
Debut 1/2" Double Cell Print Fabric Debut 3/4" Single Cell Print Fabric	Includes: Homespun, Country Woven, Florance, Strata and Angel Hair	20%
Premiere Fabric Prints	Includes: Homespun, Country Woven, Florance, Spheres, Strata, Tuscan Scroll, Angel Hair, Blossom, and Gradients	20%
Symphony Fabric	Symphony Prints and Duotones	20%
	Symphony Double Cell Flame Resistant	30%

Speciality Shaped Shades

PRICING

ROOM DARKENING & BLACKOUT FABRICS

Premiere 1/2"

Premiere 3/4"

Symphony 3/8"

PRICE GROUP 17

Trapezoids and Octagons

		Width In Inches						
		24	30	36	42	48	54	60
Length In Inches	36	865	915	978	1047	1108	1163	1224
	42	895	953	1023	1097	1163	1231	1302
	48	921	992	1074	1152	1224	1296	1375
	54	952	1027	1116	1199	1281	1365	1444
	60	983	1070	1162	1251	1338	1439	1522
	66	1017	1108	1212	1304	1403	1501	1591
	72	1047	1141	1251	1359	1463	1568	1675

All fabrics are not available in all widths, lengths and applications. Refer to Size Specifications on page 9 for availability.

Product Information: See page 73-74 for detailed information. Templates required on all Octagon orders. Width, length and one side are required measurements for Octagon Shades. **Trapezoid orders must be faxed in with a diagram that includes the measurements for 4 sides.** No templates are required for Trapezoid Shades.

FABRIC SURCHARGES		ADD
Scotchgard Stain Protector (Not available on Prelude)		\$48
Premiere Fabric Prints	Includes: Homespun, Country Woven, Florance, Spheres, Strata, Tuscan Scroll, Angel Hair, Blossom, and Gradients	20%

Comfortex Skylight and Greenhouse Shades

PRICING

LIGHT FILTERING FABRICS

Debut 1/2" Single Cell

Debut 3/4" Single Cell

Premiere 3/4"

Symphony 3/8" Double Cell

PRICE GROUP 18

Soprano Skylights

		Width In Inches					
		26	30	34	38	42	48
Length In Inches	30	741	791	842	890	940	995
	36	801	860	914	967	1023	1080
	42	862	926	986	1046	1109	1172
	48	926	995	1061	1122	1189	1263
	54	986	1066	1133	1200	1268	1348
	60	1051	1133	1205	1280	1351	1437
	72	1176	1262	1348	1435	1521	1621
	84	1301	1398	1501	1594	1686	1802
	96	1432	1535	1644	1748	1858	1986
	108	1556	1673	1786	1902	2019	2158
	120	1686	1806	1938	2063	2188	2338
	132	1809	1944	2082	2218	2354	2514
	144	1925	2083	2229	2378	2521	2699
	156	2049	2220	2378	2531		
168	2170	2359	2523	2686			
180	2288	2502	2667	2842			

ROOM DARKENING FABRICS

Premiere 3/4"

PRICE GROUP 19

Soprano Skylights

		Width In Inches					
		26	30	34	38	42	48
Length In Inches	30	965	1027	1095	1157	1219	1292
	36	1042	1116	1187	1258	1330	1404
	42	1119	1204	1281	1359	1442	1522
	48	1204	1292	1380	1459	1546	1642
	54	1281	1386	1473	1560	1651	1752
	60	1365	1473	1567	1664	1757	1867
	72	1528	1640	1752	1865	1977	2107
	84	1690	1819	1953	2070	2191	2341
	96	1860	1994	2138	2274	2416	2580
	108	2023	2175	2322	2472	2626	2804
	120	2191	2348	2521	2681	2845	3039
	132	2352	2529	2705	2883	3062	3270
	144	2503	2706	2897	3092	3275	3508
	156	2664	2886	3092	3290		
168	2819	3068	3280	3492			
180	2973	3252	3467	3694			

FABRIC SURCHARGES

ADD

Scotchgard Stain Protector (Not available on Prelude)

\$48

Debut 1/2" Single Cell Print Fabric

Includes: Homespun, Country Woven, Florance, Strata, Angel Hair, Blossom, Terrazzo and Strie

20%

Symphony Fabric

Symphony Prints and Duotones

20%

Symphony Double Cell Flame Resistant

30%

HARDWARE UPGRADE SURCHARGES* AND ACCESSORIES

ADD

Two Moving Rails

\$169

5-10 Foot Expandable Pole - Black

\$54

Comfortex Skylight and Greenhouse Shades

PRICING

LIGHT FILTERING FABRICS

Debut 1/2" Single Cell
 Debut 3/4" Single Cell
 Premiere 3/4"

Symphony 3/8"
 Double Cell

PRICE GROUP 20

Balcony Skylight Shading System

		Width In Inches				
		24	30	36	42	48
Length In Inches	36	476	541	603	674	735
	42	503	577	655	724	806
	48	528	616	694	778	865
	54	564	654	740	827	938
	60	584	691	785	877	1004
	66	616	722	825	922	1071
	72	654	761	861	963	1130
	78	691	791	900	1004	
	84	731	828	940	1046	
	90	777	861	978		
96	814	896	1020			

All fabrics are not available in all widths, lengths and applications. Refer to Size Specifications on page 10 for availability.

Product Information: See page 77 for detailed information.

- Shades are built with color coordinating hardware and white track.
- Designer metallic and fabric wrapped rails are available.

FABRIC SURCHARGES		ADD
Scotchgard Stain Protector (Not available on Prelude)		\$48
Debut 1/2" Single Cell Print Fabric	Includes: Homespun, Country Woven, Florance, Strata, Angel Hair, Blossom, Terrazzo and Strie	20%
Symphony Fabric	Symphony Prints and Duotones	20%
	Symphony Double Cell Flame Resistant	30%
HARDWARE UPGRADE SURCHARGES AND ACCESSORIES		ADD
Metallic Hardware		\$30
Fabric Wrapped Rails		\$48
3 Foot Expandable Pole - Silver		\$30
5-10 Foot Expandable Pole - Black		\$54

Comfortex Skylight and Greenhouse Shades

PRICING

BLACKOUT FABRICS

Premiere 3/4"
 Symphony 3/8" Double Cell

PRICE GROUP 21

Balcony Skylight Shading System

		Width In Inches				
		24	30	36	42	48
Length In Inches	36	618	703	785	876	953
	42	654	749	850	944	1047
	48	686	801	903	1011	1124
	54	732	849	963	1074	1218
	60	760	899	1019	1141	1305
	66	801	940	1073	1199	1391
	72	849	990	1118	1251	1467
	78	899	1027	1171	1305	
	84	948	1078	1219	1359	
	90	1010	1118	1270		
96	1057	1163	1326			

Product Information: See page 77 for detailed information.

- Shades are built with color coordinating hardware and white track.
- Designer metallic and fabric wrapped rails are available.

FABRIC SURCHARGES		ADD
Scotchgard Stain Protector <i>(Not available on Prelude)</i>		\$48
Symphony Fabric	Symphony Prints and Duotones	Add 20%
	Symphony Double Cell Flame Resistant	Add 30%
HARDWARE UPGRADE SURCHARGES AND ACCESSORIES		ADD
Metallic Hardware		\$30
Fabric Wrapped Rails		\$48
3 Foot Expandable Pole - Silver		\$30
5-10 Foot Expandable Pole - Black		\$54

Comfortex Skylight and Greenhouse Shades

PRICING

LIGHT FILTERING FABRICS

Debut 1/2" Single Cell

Debut 1/2" Double Cell

Debut 3/4" Single Cell

Premiere 1/2"

Premiere 3/4"

Symphony 3/8"

PRICE GROUP 22

Mezzo Motorized Skylights - White Rail and White Tracks

		Width In Inches				
		24	30	36	42	48
Length In Inches	36	592	673	752	844	916
	42	628	718	815	904	1005
	48	663	770	867	970	1079
	54	702	815	925	1032	1167
	60	731	861	977	1097	1254
	66	770	900	1027	1154	1338
72	815	952	1074	1200	1410	

Be sure to add the Simplicity motor surcharges and upgrades to the grid above. Shades and motors are priced separately to ensure that percent surcharges apply only to the shade and not the motor.

Product Information: See page 77 for detailed information.

- Mezzo Shades are built with white rail and white track.

FABRIC SURCHARGES		ADD
Scotchgard Stain Protector (Not available on Prelude)		\$48
Debut 1/2" Single Cell Print Fabric	Includes: Homespun, Country Woven, Florance, Strata, Angel Hair, Blossom, Terrazzo and Strie	20%
Debut 1/2" Double Cell Print Fabric Debut 3/4" Single Cell Print Fabric	Includes: Homespun, Country Woven, Florance, Strata and Angel Hair	20%
Premiere Fabric Prints	Includes: Homespun, Country Woven, Florance, Spheres, Strata, Tuscan Scroll, Angel Hair, Blossom, and Gradients	20%
Symphony Fabric	Symphony Prints and Duotones	20%
	Symphony Double Cell Flame Resistant	30%
MOTORIZATION - HARDWARE UPGRADE SURCHARGES AND ACCESSORIES		MORE INFO
Simplicity - Motor and Rechargeable Battery Pack		Pg 52
Simplicity 14 Channel White Remote		Pg 58
48" Extension Wire:		Pg 58
Simplicity Smart Controller (NEO)		Pg 61
7.4v Solar Panel & Mounting Brackets		Pg 55
Plug-In Charger for 7.4V Li-Ion Rechargeable Battery Pack		Pg 54
		ADD
		\$300
		\$50
		\$10
		\$280
		\$120
		\$30

Comfortex Skylight and Greenhouse Shades

PRICING

ROOM DARKENING & BLACKOUT FABRICS

Premiere 1/2"

Premiere 3/4"

Symphony 3/8"

PRICE GROUP 23

Mezzo Motorized Skylights - White Rail and White Tracks

		Width In Inches				
		24	30	36	42	48
Length In Inches	36	769	874	978	1096	1190
	42	815	932	1061	1177	1308
	48	862	1001	1128	1262	1403
	54	912	1059	1203	1341	1517
	60	948	1118	1268	1426	1629
	66	1001	1171	1335	1500	1741
	72	1059	1238	1397	1560	1835

Be sure to add the Simplicity motor surcharges and upgrades to the grid above.

Product Information: See page 79 rail and white track.

FABRIC SURCHARGES		ADD	
Scotchgard Stain Protector (Not available on Prelude)		\$48	
Premiere Fabric Prints	Includes: Homespun, Country Woven, Florance, Spheres, Strata, Tuscan Scroll, Angel Hair, Blossom, and Gradients	Add 20%	
MOTORIZATION - HARDWARE UPGRADE SURCHARGES AND ACCESSORIES		MORE INFO	ADD
Simplicity - Motor and Rechargeable Battery Pack		Pg 52	\$300
Simplicity 14 Channel White Remote		Pg 58	\$50
48" Extension Wire:		Pg 58	\$10
Simplicity Smart Controller (NEO)		Pg 61	\$280
7.4v Solar Panel & Mounting Brackets		Pg 55	\$120
Plug-In Charger for 7.4V Li-Ion Rechargeable Battery Pack		Pg 54	\$30

French Door Décor Shades
PRICING

LIGHT FILTERING FABRICS

Debut 1/2" Single Cell Premiere 1/2"
 Debut 1/2" Double Cell Premiere 3/4"
 Debut 3/4" Single Cell Symphony 3/8"

PRICE GROUP 24
Non-Movable French Door Décor

		Width In Inches		
		24	30	36
Length In Inches	36	155	175	198
	42	166	189	212
	48	176	202	230
	54	187	214	247
	60	200	229	261
	66	209	244	280
	72	219	255	296
	78	230	268	310
	84	238	281	323
	90	251	294	341
96	257	305	355	

Product Information: See page 82 for detailed information.

FABRIC SURCHARGES		ADD
Scotchgard Stain Protector <i>(Not available on Prelude)</i>		\$48
Debut 1/2" Single Cell Print Fabric	Includes: Honespun, Country Woven, Florance, Strata, Angel Hair, Blossom, Terrazzo and Strie	20%
Premiere Fabric Prints	Includes: Honespun, Country Woven, Florance, Spheres, Strata, Tuscan Scroll, Angel Hair, Blossom, and Gradients	20%
Symphony Fabric	Symphony Prints and Duotones	20%
	Symphony Double Cell Flame Resistant	30%
HARDWARE UPGRADE SURCHARGES AND ACCESSORIES		ADD
Metallic Hardware		\$30
Fabric Wrapped Rails		\$48

French Door Décor Shades
PRICING

LIGHT FILTERING FABRICS

PRICE GROUP 25
Movable French Door Décor

Not Offered as of April 21, 2024

French Door Décor Shades
PRICING

ROOM DARKENING & BLACKOUT FABRICS

PRICE GROUP 26
Non-Movable French Door Décor

Premiere 1/2"
 Premiere 3/4"
 Symphony 3/8"

		Width In Inches		
		24	30	36
Length In Inches	36	202	226	257
	42	216	246	275
	48	229	263	299
	54	242	277	321
	60	259	298	339
	66	272	316	365
	72	284	331	384
	78	299	348	403
	84	310	368	422
	90	327	381	443
96	335	398	461	

Product Information: See page 82 for detailed information.

FABRIC SURCHARGES		ADD
Scotchgard Stain Protector <i>(Not available on Prelude)</i>		\$48
Premiere Fabric Prints	Includes: Homespun, Country Woven, Florance, Spheres, Strata, Tuscan Scroll, Angel Hair, Blossom, and Gradients	20%
Symphony Fabric	Symphony Prints and Duotones	20%
	Symphony Double Cell Flame Resistant	30%
HARDWARE UPGRADE SURCHARGES AND ACCESSORIES		ADD
Metallic Hardware		\$30
Fabric Wrapped Rails		\$48

French Door Décor Shades
PRICING

ROOM DARKENING & BLACKOUT FABRICS

PRICE GROUP 27
Movable French Door Décor

Not Offered as of April 21, 2024



**7.4V Rechargeable
Simplicity Motorization**



**7.4V Rechargeable
Powertouch**



Cordless Ultra Hardware



Ovation Hardware



**Cordless Lift & Lock
Hardware**



**Insulating Slumbershades
Hardware**



**12V Non-Rechargeable
Simplicity Motorization**



**Specialty Shape
Hardware**

Not Offered as of April 21, 2024

Cellular Shade Collection
STANDARD CORD LOCK SHADES HARDWARE SYSTEM

Not Offered as of April 21, 2024

Cellular Shade Collection
CORD LOOP HARDWARE SYSTEM

Not Offered as of April 21, 2024

Cellular Shade Collection
CORD LOOP HARDWARE SYSTEM

Not Offered as of April 21, 2024

Cellular Shade Collection

CORDLESS ULTRA HARDWARE SYSTEM

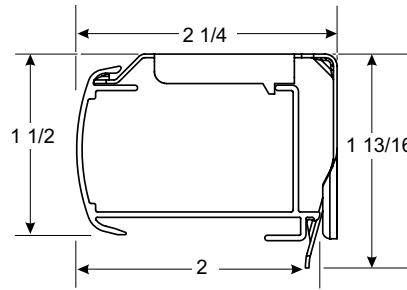

Cord Loop Rail Dimensions

- Depth of rail: 2"
- Depth of rail and bracket: 2 1/4"
- Height of rail: 1 1/2"
- Height of bracket: 1 13/16"

Hardware Features	
Hardware colors for all Cellular fabrics (Symphony Blackout Not Available)	Color coordinated head, bottom rails and end caps
Standard Hardware for all Custom Graphics	White head, bottom rails and end caps
Upgrades	
Fabric Wrapped Upgrade	Fabric used is same fabric as the shade. Back of rail is white to outside. End caps on fabric wrapped head and bottom rails are color coordinated
Designer Metallic Upgrade	<ul style="list-style-type: none"> • Smooth faced Oil Rubbed Bronze head, bottom rails and end caps

Mounting Dimensions	Hardware System
Minimum Shallow Mount	1/2"
Minimum Flush Inside Mount	2 1/4"
Minimum Outside Mount	7/8"
Minimum Side Mount	1 1/4"
Minimum Flush Side Mount	2 1/4"
Recommended Side Mounting Method	<ul style="list-style-type: none"> • See figure A on page 47 for recommended mounting method for side mount shades • Width limit for side mount brackets is 48"

Finished Dimensions	
Inside Mount	
	<ul style="list-style-type: none"> • Fabric will measure ordered width less: 3/8" • Head rail* will measure ordered width less: 3/16"
Outside Mount	
	<ul style="list-style-type: none"> • Fabric will measure ordered width • Head rail* will measure ordered width plus: 3/16"
Side Mount	
	<ul style="list-style-type: none"> • Fabric will measure ordered width less: 7/8" • Head rail* will measure ordered width less: 1 1/16"
Exact (End Cap to End Cap) Mount	
	<ul style="list-style-type: none"> • Fabric will measure ordered width less: 3/16" • Head rail* will measure ordered width

* Head rail measurements include endcaps. Width and length measurements may vary +/- 1/8"

Cellular Shade Collection

CORDLESS ULTRA HARDWARE SYSTEM

Applications

- Standard Rectangular
- Top Down - Bottom Up
- Insulating SlumberShades
- Two-On-One Head Rail

Things to Consider

- Is the top of your window out of reach? You can order an extension pole to reach but it can still be tricky. You may want to consider Motorized hardware.
- For shades mounted on doors, you may want to order hold down brackets.
- If privacy is an issue, consider Top Down-Bottom Up options.

Ordering Information for Cordless Ultra Hardware Shades

Standard Rectangular

- Specify IB or OB mount and rail color.

Top Down - Bottom Up

- Specify IB or OB mount and rail color.
 Middle rail will match the head and bottom rails.

Insulating SlumberShades

See pages 66 for more information.

Accessories

- 3' Expandable Pole - Silver:
- 5-10' Expandable Pole - Black:



3' Pole

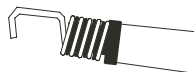

5-10' Pole End

Specially designed pole end fits into the handle on the bottom rail and allows for easy operation.

Cordless Ultra and Cordless Ultra Top Down - Bottom Up Hardware Features

- Children and pets have safer surroundings in homes that have window shades without operating cords, reducing the risk of strangulation.
- Cordless Ultra and Cordless Ultra Top Down - Bottom Up Shades can be raised or lowered with a gentle push or pull on the rail handle.
- Cordless Ultra Top Down - Bottom Up Shades feature two moving rails.
- Order an operating pole for out of reach applications.

Cordless Ultra Shade Operation

Cordless shades should be operated from the handle located in the center of the bottom rail. Using the handle will aid in smooth and easy shade operation. Two handles are supplied on wider width shades.

To lower the shade, pull down on the handle which is secured to the bottom rail and guide the rail to desired position (Figure A). For out of reach applications, an optional extension pole should be used.

To raise the shade, push the bottom rail up using the handle on the bottom rail and guide the rail to the desired position. The shade will hold any position when the bottom rail is released. Raise the shade slowly and steadily to allow the shade to stack evenly (Figure B).

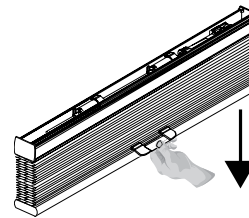

Figure A

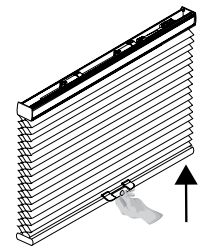

Figure B

New Sleek 3' Pole

Optional



Recommended Mounting Method for Side Mounting Shades

See Page 47.

EZ Level on Cellular Shades

EZ Level makes quick work of leveling without cords to cut or tuck into a rail. See page 91 for details.

Cellular Shade Collection

CORDLESS LIFT & LOCK HARDWARE SYSTEM

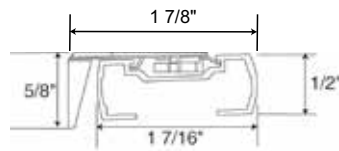

Standard Top Rail

- Depth of rail: 17/16"
- Depth of rail and bracket: 17/8"
- Height of rail: 1/2"
- Height of bracket: 5/8"

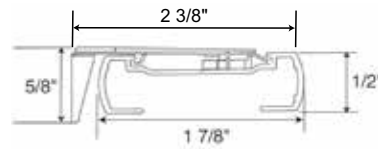

Deluxe Top Rail

- Depth of rail: 17/8"
- Depth of rail and bracket: 23/8"
- Height: 1/2"
- Height of bracket: 5/8"

Hardware Features	
Hardware colors for all Cellular fabrics	Color coordinated head, middle and bottom rails with color coordinated push button/handle on the middle and bottom rails
Standard Hardware for all Custom Graphics	White head, middle and bottom rails with white cord
Upgrades	
Fabric Wrapped Upgrade	Fabric used is same fabric as the shade. Back of rail is white to outside. All shades will have a color coordinated push button and handle on the middle /bottom rail. Color coordinated end caps.
Designer Metallic Upgrade	<ul style="list-style-type: none"> • Oil Rubbed Bronze head, middle, bottom rails and end caps. • Oil Rubbed Bronze push button/handle on the middle and bottom rails.
Mounting Dimensions	
Minimum Shallow Mount	Standard Head Rail: 3/4" Deluxe Head Rail: 3/4"
Minimum Flush Inside Mount	Standard Head Rail: 2" Deluxe Head Rail: 2 1/2"
Minimum Outside Mount	Standard Head Rail: 3/4" Deluxe Head Rail: 3/4"
Minimum Side Mount	Standard Head Rail: 1 1/8" Deluxe Head Rail: 1 3/8"
Minimum Flush Side Mount	Standard Head Rail: 1 5/8" Deluxe Head Rail: 1 7/8"
Recommended Side Mounting Method	<ul style="list-style-type: none"> • See figure A (pg 47) for recommended mounting method for side mount shades • Width limit for side mount brackets is 48"
Finished Dimensions	
Inside and Side Mount	
	<ul style="list-style-type: none"> • Fabric will measure ordered width less: 3/8" • Head rail* will measure ordered width less: 3/16"
Outside Mount	
	<ul style="list-style-type: none"> • Fabric will measure ordered width • Head rail* will measure ordered width plus: 3/16"
Exact (End Cap to End Cap) Mount	
	<ul style="list-style-type: none"> • Fabric will measure ordered width less: 3/16" • Head rail* will measure ordered width
* Head rail measurements include endcaps. Width and length measurements may vary +/- 1/8"	

Cellular Shade Collection

CORDLESS LIFT & LOCK HARDWARE SYSTEM

Cordless Lift & Lock Shades Hardware System Bottom Rail Dimensions

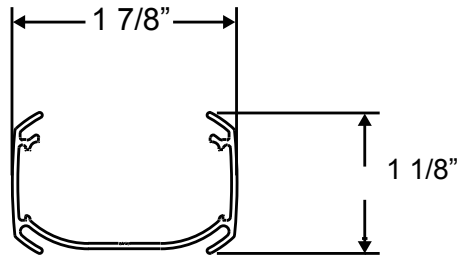

- Depth of rail: 1 7/8"
- Height of rail: 1 1/8"

Applications

- Standard Rectangular
- Top Down-Bottom Up
- Two-On-One Headrail

Standard size head rail hardware is used on 1/2" and 3/8" fabrics. These fabrics include: 1/2" Debut (all), 1/2" Premiere, Symphony, and Symphony Blackout.

Deluxe size head rail hardware is used on 3/4" Premiere, Linen Weave, Verona, Boutique and 3/4" Debut.

The bottom rail is the same size for all fabrics.

- Two-On-One headrail price as 2 separate shades and add \$66 (not available in Top Down-Bottom Up)

Important Operating Note on Cordless Lift & Lock Shades

- To operate a Cordless Lift & Lock Shade, the middle or bottom rails must be accessible. An extension pole is not available for Cordless Lift & Lock Shades.

Cordless Lift & Lock Hardware Features

- Children and pets have safer surroundings in homes that have window shades without operating cords, reducing the risk of strangulation.
- Cordless Lift & Lock Shades can be raised or lowered by pressing the button located on the bottom rail and guiding the rail into the desired location.

Things to Consider

- Is the top of your window out of reach? To operate a Cordless Lift & Lock Shade, the bottom rail must be accessible. If the bottom or middle rail is not accessible, you may want to consider Cord Loop, Cordless Ultra or Motorized hardware. An extension pole is not available for Cordless Lift & Lock Shades.
- For shades mounted on doors, you may want to order hold down brackets.

Ordering Information for Cordless Lift & Lock Shades

Standard Rectangular

- Specify IB or OB mount and rail color.

Cordless Lift & Lock Shade Operation

Cordless Lift & Lock Shades are operated using the push button handle located in the center of the bottom rail.

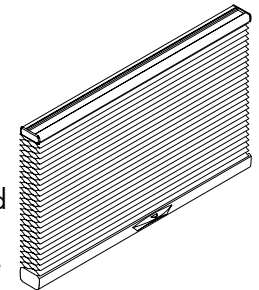

To raise or lower the shade; press the button on the shade handle, and guide the rail to desired position. Release the button to lock the shade into place.

The shade will hold in any position when the button is released. Raise the shade slowly and steadily to allow the shade to stack evenly.

NOTE: Lift and Lock shades do not utilize the EZ Level plugs like other Comfortex rectangular shade hardware systems. The bottom rail equalization can be adjusted using the tie-off plugs on the top of the headrail. Middle rail of TDBU has an adjusting tool inside the rail. Access by removing the right side endcap.

Cellular Shade Head Rail Options

12V NON-RECHARGEABLE SIMPLICITY MOTORIZED CELLULAR SHADES

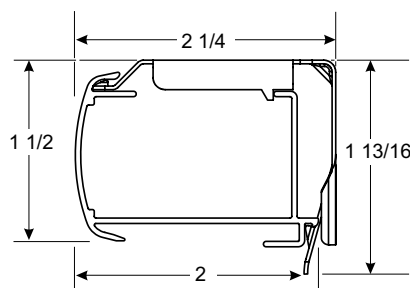
**Simplicity Motorized Rail Dimensions**

- Depth of rail: 2"
- Depth of rail and bracket: 2 1/4"
- Height of rail: 1 1/2"
- Height of bracket: 1 13/16"

Hardware Features

Hardware colors for all Cellular fabrics	Color coordinated head, bottom rails and end caps
Standard Hardware for all Custom Graphics	White head and bottom rails and end caps
Simplicity Remote	Upper and lower limit stops pre-programmed, Intermediate stop "favorites" position can be set on-site.

Upgrades

Fabric Wrapped Upgrade	Fabric used is same fabric as the shade. Back of rail is white to outside. End caps on fabric wrapped head and bottom rails are color coordinated
Designer Metallic Upgrade	<ul style="list-style-type: none"> • Smooth faced Oil Rubbed Bronze head, bottom rails and end caps

Mounting Dimensions**Simplicity Motorized Hardware System**

Minimum Shallow Mount	1/2"
Minimum Flush Inside Mount	2 1/4"
Minimum Outside Mount	7/8"
Minimum Side Mount	1 1/4"
Recommended Side Mounting Method	<ul style="list-style-type: none"> • See page 47 for recommended mounting method for side mount shades • Width limit for side mount brackets is 48"

Finished Dimensions**Inside Mount**

- Fabric will measure ordered width less: 3/8"
- Head rail* will measure ordered width less: 3/16"

Outside Mount

- Fabric will measure ordered width
- Head rail* will measure ordered width plus: 3/16"

Side Mount

- Fabric will measure ordered width less: 7/8"
- Head rail* will measure ordered width less: 1 1/16"

Exact (End Cap to End Cap) Mount

- Fabric will measure ordered width less: 3/16"
- Head rail* will measure ordered width

* Head rail measurements include endcaps. Width and length measurements may vary +/- 1/8"

Cellular Shade

12V NON-RECHARGEABLE SIMPLICITY MOTORIZED CELLULAR SHADES

Simplicity Motors

The Simplicity Motor program features a battery powered 12V motor utilizing a single battery wand or plug-in DC transformer. Simplicity motors are compact and use a radio frequency remote to raise or lower the shades.

Motorized Lift Systems are not offered on sizes within the shaded area on the Standard Rectangular price grids.

- Length measurements may vary +/- 1/8".

Applications

- Standard Rectangular
- Two-On-One Head Rail Bottom Up

EZ Level

[Learn about the EZ Level feature on page 91.](#)

Simplicity Motorization Surcharges

The standard Simplicity Motorized Lift System surcharge includes a 12 volt battery wand with eight AA alkaline batteries. Remotes are needed to operate the shades. See pricing pages.

Important Simplicity Motorized Shade Operating and Installation Information

- Simplicity Motorized Shades installed into windows with metal casings may have a reduced radio frequency range, or may not operate at all, depending on the application.
- Do not let the antenna on the motor touch any metal objects. This may interfere with signals from the remote control.

Simplicity Battery Wand

Batteries are needed to operate Simplicity motors. The battery wand can be clipped to the head rail or wall or ceiling mounted utilizing white battery wand clips. The 12 volt battery wand measures 17 1/4", and comes with eight AA alkaline batteries, and is white in color.

The battery wire is 10" long. A 48" extension wire is available.



Simplicity Motor Battery Life and Replacement

Eight alkaline batteries are included with the wand. The battery life will vary based on the type of window covering selected, the size and weight of the window covering and the number of times you operate the shade on a daily basis. For example, a 36" x 60" single honeycomb shade operated twice daily will commonly have a battery life which lasts up to 18 months.

Comfortex will warranty batteries for up to 3 months from date of purchase.

Simplicity Hand Held Remote 14 Channel Remote

The TDBU remote has 14-channels. This remote is required for TDBU motorization but can be utilized on all Simplicity motorized shades. Each channel has a setting to operate the middle rail and a setting to operate the bottom rail. The TDBU remote is required for TDBU motors. The **14 Channel TDBU remote** can operate up to fourteen shades individually or 14 groups. Simplicity Rechargeable Motorized Cellular Shades are programmed at the factory with the "up and down" limits. The shades are **UNLINKED** from the remote so they are not able to operate during shipping. Each shade should be installed **after** linking it to the remote.



Simplicity TDBU remotes and holders are white or black in color. The remote comes with a holder which can be mounted to a wall for easy storage. The range of the remote is approximately 80 feet.

DC Power Supply/Transformer

12 Volt DC power supply/transformer is available and requires a standard power outlet to power the motor. The transformer is an alternative to a battery wand. Each transformer can power a single shading. The power supply must plug in to the motor. The DC power supply is black and comes with a 80" wire. The dimensions are 1 7/8" wide x 3 1/4" long x 1 1/4" deep



12V Simplicity Low Voltage Hardwiring System

[Learn about the 12V Low Voltage Hardwiring System on page 60.](#)

SIMPLICITY MOTORIZATION PRICING EXAMPLE:

Debut 1/2"	
Light Filtering 42" x 60" Shade:	\$417.00
Simplicity Motor Surcharge:	\$300.00
Simplicity Remote Control:	\$50.00
Total List Price:	\$767.00

Cellular Shade Collection

7.4V RECHARGEABLE SIMPLICITY MOTORIZED HARDWARE SYSTEM

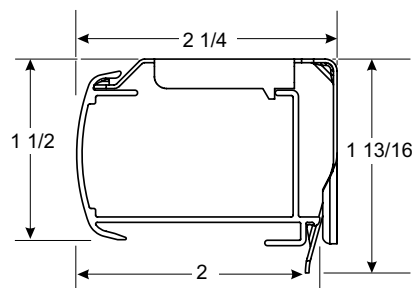
**Rechargeable Simplicity Rail Dimensions**

- Depth of rail: 2"
- Depth of rail and bracket: 2 1/4"
- Height of rail: 1 1/2"
- Height of bracket: 1 13/16"

Hardware Features

Hardware colors for all Cellular fabrics	Color coordinated head, bottom rails and end caps
Standard Hardware for all Custom Graphics	White head and bottom rails and end caps

Upgrades

Fabric Wrapped Upgrade	Fabric used is same fabric as the shade. Back of rail is white to outside. End caps on fabric wrapped head, middle and bottom rails are color coordinated
Designer Metallic Upgrade	<ul style="list-style-type: none"> • Smooth faced Oil Rubbed Bronze head, middle, bottom rails and end caps

Mounting Dimensions**Rechargeable Simplicity Motorization Hardware System**

Minimum Shallow Mount	1/2"
Minimum Flush Inside Mount	2 1/4"
Minimum Outside Mount	7/8"
Minimum Side Mount	1 1/4"
Minimum Flush Side Mount	2 1/4"
Recommended Side Mounting Method	<ul style="list-style-type: none"> • See page 47 for recommended mounting method for side mount shades • Width limit for side mount brackets is 48"

Finished Dimensions**Inside Mount**

- Fabric will measure ordered width less: 3/8"
- Head rail* will measure ordered width less: 3/16"

Outside Mount

- Fabric will measure ordered width
- Head rail* will measure ordered width plus: 3/16"

Side Mount

- Fabric will measure ordered width less: 7/8"
- Head rail* will measure ordered width less: 1 1/16"

Exact (End Cap to End Cap) Mount

- Fabric will measure ordered width less: 3/16"
- Head rail* will measure ordered width

* Head rail measurements include endcaps. Width and length measurements may vary +/- 1/8"

Cellular Shade Collection

7.4V RECHARGEABLE SIMPLICITY MOTORIZED HARDWARE SYSTEM

Rechargeable Simplicity Motors

The Simplicity Motor program features a battery powered motor utilizing a rechargeable battery hidden inside the shade head rail. Simplicity motors are compact and use a radio frequency remote to raise or lower the shades.

Rechargeable Motorized Lift Systems are not offered on sizes within the shaded area on the Standard Rectangular price grids.

Applications

- Standard Rectangular
- Top Down-Bottom Up see page 57
- Two-On-One Head Rail Bottom Up

EZ Level

Learn about the EZ Level feature on page 91.

Rechargeable Simplicity Motorization Surcharges

The Rechargeable Simplicity Motorized Lift System surcharge includes a rechargeable battery. Remotes are needed to operate the shades. Refer to pricing pages.

Important Simplicity Motorized Shade Operating and Installation Information

- Simplicity Motorized Shades installed into windows with metal casings may have a reduced radio frequency range, or may not operate at all, depending on the application.
- Do not let the antenna on the motor touch any metal objects. This may interfere with signals from the remote control.

Simplicity Rechargeable Battery

The rechargeable battery is concealed in the head rail of the shade. A charger is required for the rechargeable battery. The rechargeable battery comes fully charged from the factory.



Charging Port on Back of Head rail.

RECHARGEABLE SIMPLICITY PRICING EXAMPLE:

Debut 1/2"	
Light Filtering 42" x 60" Shade:	\$417.00
Simplicity Rechargeable Surcharge:	\$300.00
Charger for Rechargeable :	\$30.00
Simplicity Remote Control:	\$50.00
Solar Panel & Mounting Brackets:	\$120.00
Total List Price:	\$917.00

Solar Panel Recharge Option

Plugs in to any Simplicity Rechargeable Remote control shade (does not work with PowerTouch)

Provides constant trickle charge to 7.4v Li-Ion Rechargeable battery packs. Will prolong the life of the charge of the 7.4v rechargeable battery packs, and in some applications will maintain charge indefinitely.

Life of charge is subject to application variables such as, size and weight of shade, frequency of use, amount of direct sunlight exposure, etc.

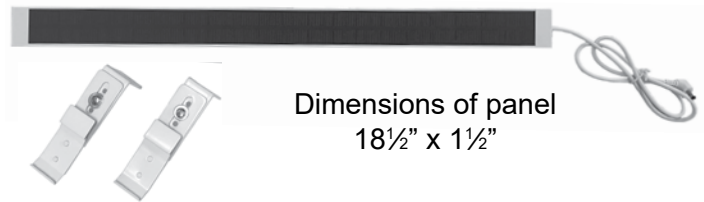

Dimensions of panel
18 1/2" x 1 1/2"

- Solar Panel with Mounting Brackets: \$120.00

Solar Recharge Optimum Application

- Full direct sunlight (minimum 2 hours per day) to maintain full charge. Based on one operation cycle per day (one open, one close).
- Excessive duration of cloudy weather will impact the rate of charge.
- Avoid any obstructions including mullions and screens.

Solar Panel Mounting

Bottom portion of the bracket may be lowered if needed for more sun exposure. Bracket can be mounted behind or next to shade mounting bracket.

Bracket Method

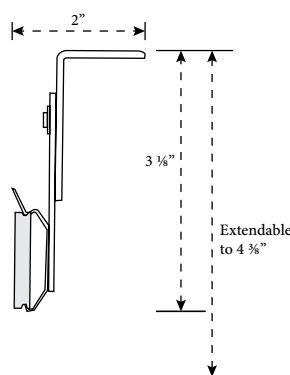

Tape Method

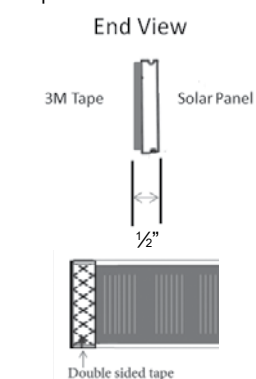

Tape goes on the face (black side) of the panel.

If the solar panel is mounted directly behind the headrail at the top of the window, you need to make sure that the solar panel does not interfere with the shade mounting brackets also. The solar panel can go between brackets spaced apart, or behind brackets if the depth of the window casing allows.

Cellular Shade Collection

7.4V RECHARGEABLE SIMPLICITY MOTORIZED HARDWARE SYSTEM

Simplicity Rechargeable Battery Life

Rechargeable batteries are included with the motor.

The average battery charge will last 6-12 months based on an average sized shade raised and lowered once per day. The life of the battery charge will vary based on the type of window covering selected, the size and weight of the window covering and the number of times the shade is operated on a daily basis.

The battery can be recharged up to 500 times. It takes approximately 5 hours to recharge the motor when fully depleted.

Ordering Information for Rechargeable Motorized Cellular Shades

Simplicity Motor Option

- Specify IB or OB mount and rail color.
- Specify remote and other accessories if needed.
- Specify one or more battery chargers.

Please Note:

- Not all motors run at the same rate of speed.
- Simplicity motors have a "Favorites" position setting. If the homeowner wants to set several shades at the same intermediate position, follow instructions provided with installation manual.
- Simplicity Rechargeable Motorized Cellular Shades are programmed at the factory with the "up and down" limits. The shades are **UNLINKED** from the remote so they are not able to operate during shipping. Each shade should be installed **after** linking it to the remote.
- The Simplicity remotes utilize one 3V battery. Batteries are included. Comfortex will warranty batteries for up to 3 months from date of purchase.
- **REMEMBER: Order at least one charger if ordering rechargeable motors.**

Simplicity Motorized Shade Warranty

Please see Policy PDF for complete Comfortex warranty information.

Battery Charger

8.4 Volt charger requires a standard power outlet to recharge the battery. You must specify charger when ordering a Simplicity Rechargeable Shade. The charger plugs into the charger port. The charger is black and comes with a 156" wire. The dimensions are 1" wide x 2½" length x 1¾" deep.



Simplicity Hand Held Remote

14 Channel Remote

The TDBU remote has 14-channels. This remote is required for TDBU motorization but can be utilized on all Simplicity motorized shades. Each channel has a setting to operate the middle rail and a setting to operate the bottom rail. The TDBU remote is required for TDBU motors. The **14 Channel TDBU remote** can operate up to fourteen shades individually or 14 groups. Simplicity Rechargeable Motorized Cellular Shades are programmed at the factory with the "up and down" limits. The shades are **UNLINKED** from the remote so they are not able to operate during shipping. Each shade should be installed **after** linking it to the remote.



Simplicity TDBU remotes and holders are white or black in color. The remote comes with a holder which can be mounted to a wall for easy storage. The range of the remote is approximately 80 feet.

Simplicity Motor Hand Held Remotes Operation

Press the up or down button on the remote to raise or lower the shade to your desired position.

To reprogram channel assignments, please refer to the installation instructions and/or view the video at: comfortex.com/comfortex-dealers.

Cellular Shade Collection

7.4V RECHARGEABLE MOTORIZED TOP DOWN-BOTTOM UP HARDWARE SYSTEM

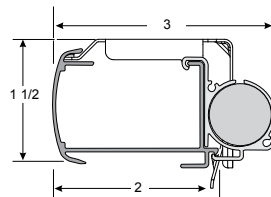
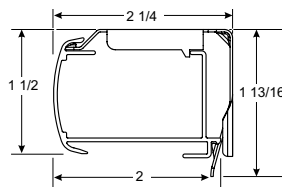
**Simplicity Motorized Rail Dimensions**

- Depth of rail: 2"
- Depth of rail and bracket: 2 1/4"
- Height of rail: 1 1/2"
- Height of bracket: 1 13/16"

Simplicity Motorized Rail with External Battery Dimensions (shades under 36")

- Depth of rail: 2"
- Depth of rail, bracket & battery: 3"
- Height of rail: 1 1/2"
- Height of bracket: 1 13/16"

Hardware Features

Standard Hardware	• Color coordinated head, middle, and bottom rails.
14 Channel TDBU Remote	Upper and lower limit stops pre-programmed
Upgrades	
Designer Metallic Upgrade	• Smooth faced Designer Oil Rubbed Bronze head, middle, bottom rails and end caps
Fabric Wrapped Rails	• Fabric used to cover the rails is the same fabric as the shade. The back of the rail will be white to the outside. End Caps will be color coordinated.

Mounting Dimensions

Mounting Dimensions	Simplicity Motorized Hardware System
Minimum Shallow Mount	1/2"
Minimum Flush Inside Mount	2 1/4"
Minimum Outside Mount	7/8"
Minimum Side Mount	1 1/4"
Recommended Side Mounting Method	<ul style="list-style-type: none"> • See page 47 for recommended mounting method for side mount shades • Width limit for side mount brackets is 48"

Finished Dimensions**Inside Mount**

	<ul style="list-style-type: none"> • Fabric will measure ordered width less: 3/8" • Head rail* will measure ordered width less: 3/16"
--	---

Outside Mount

	<ul style="list-style-type: none"> • Fabric will measure ordered width • Head rail* will measure ordered width plus: 3/16"
--	--

Side Mount

	<ul style="list-style-type: none"> • Fabric will measure ordered width less: 7/8" • Head rail* will measure ordered width less: 1 1/16"
--	---

Exact (End Cap to End Cap) Mount

	<ul style="list-style-type: none"> • Fabric will measure ordered width less: 3/16" • Head rail* will measure ordered width
--	--

* Head rail measurements include endcaps. Width and length measurements may vary +/- 1/8"

Cellular Shade Collection

7.4V RECHARGEABLE MOTORIZED TOP DOWN-BOTTOM UP HARDWARE SYSTEM

Rechargeable Simplicity Motors

The Simplicity TDBU Motor program features a battery powered motor utilizing a rechargeable battery hidden inside the shade head rail. If shades are less than 36" in width, an external snap-on battery pack is necessary.

(See picture to right)

Applications

- TDBU Rectangular/ Two-On-One Head Rail

EZ Level

Learn about the EZ Level feature on page 91.

Rechargeable Simplicity Motorization Surcharges

The Rechargeable Simplicity Motorized Lift System surcharge includes a rechargeable battery. Remotes are needed to operate the shades. Refer to pricing pages.

Ordering Information for Top Down-Bottom Up Motorized Cellular Shades

Simplicity Motor Option

- Specify IB or OB mount and rail color.
- 14 Channel TDBU Remote is required.
- Specify one or more battery chargers.

Please Note:

- Shades that are 24"-36" in width will have an external battery.
- Shades with an external battery and OB mounted will need spacer blocks.
- Simplicity Rechargeable Motorized Cellular Shades are programmed at the factory with the "up and down" limits.
- **REMEMBER: Order at least one charger if ordering rechargeable motors.**

Top Down-Bottom Up Simplicity Motor Hand Held 14 Channel Remote

The TDBU remote has 14-channels. Each channel has a setting able to operate the middle rail and a setting able to operate the bottom rail. The TDBU remote is required for TDBU motors, but can be used with other motors as well. The **14 Channel TDBU remote** can operate up to fourteen shades individually or 14 groups. Simplicity Rechargeable Motorized Cellular Shades are programmed at the factory with the "up and down" limits. The shades are **UNLINKED** from the remote so they are not able to operate during shipping. Each shade should be installed **after** linking it to the remote.



Simplicity TDBU remotes and holders are white in color. The remote comes with a holder which can be mounted to a wall for easy storage. The range of the remote is approximately 80 feet. A **14 Channel (14C) remote** can be utilized on all Simplicity motorized shades.

Simplicity Rechargeable Battery for TDBU

The rechargeable battery is concealed in the head rail of the shade. A charger is required for the rechargeable battery. The rechargeable battery comes fully charged from the factory.

Rechargeable Battery Pack is concealed in the head rail. Minimum width 36" or less is required otherwise battery wand must be mounted externally.

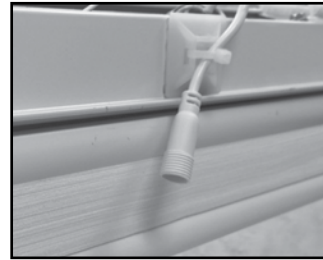

Charging Port on Back of Head rail.

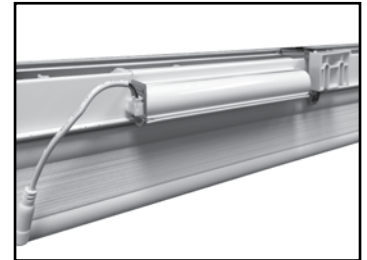

Snap-On external battery for TDBU shades 36" or less in width. Spacer block also required for outside mount.

Battery Charger

8.4 Volt charger requires a standard power outlet to recharge the battery. You must specify charger when ordering a Simplicity Rechargeable Shade. The charger plugs into the charger port. The charger is black and comes with a 156" wire. The dimensions are 1" wide x 2 1/2" length x 1 3/4" deep.

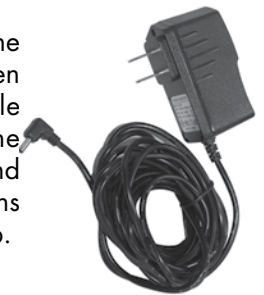

Solar Panel Recharge Option

Plugs in to any Simplicity Rechargeable Remote control shade (does not work with PowerTouch). See page 55.

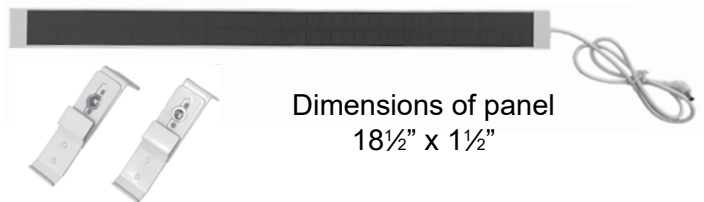

Dimensions of panel
18 1/2" x 1 1/2"

MOTORIZED TOP DOWN-BOTTOM UP PRICING EXAMPLE:

Debut 1/2"	
Light Filtering 42" x 60" Shade:	\$417.00
Simplicity Rechargeable	
TDBU Surcharge:	\$515.00
Charger for Rechargeable:	\$30.00
TDBU Remote Control:	\$50.00
Total List Price:	\$1012.00

Cellular Shade Collection

7.4V RECHARGEABLE SIMPLICITY HARDWARE SYSTEM

EZ Charge Extension Wand Option

EZ Charge Extension Wand is the newest innovation in rechargeable motorization. Easily charge your hard to reach Simplicity Rechargeable Shades with the EZ Charge Extension Wand to charge. The wand extends up to 31" in length.

Simple to use! Place the magnetized wand tip to the receiving port to attach. Then plug the charger into the base of the wand. It is that simple!

- EZ Charge Extension Wand can be easily concealed by a valance or drapery panel.
- Great for out of reach windows

EZ Charge Wall Mount Receiver

- The EZ Charge Wall Mount Receiver includes screws and anchors. These can be used for wood or drywall mounting.
- Extension cable plugs into charging port of Simplicity Rechargeable shades.

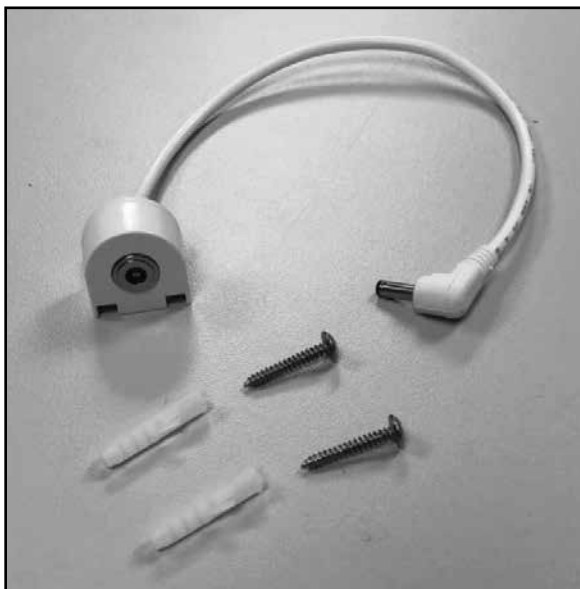

EZ Charge Wall Mount Receiver Kit | CKIT078
 One kit per Simplicity Motorized shade is needed.

EZ Charge Wand

- Wand is 9½" and extends to 31" Magnetized tip makes connection quick and easy.
- Once wand is in place plug the 8.4v charger into the bottom of the extension wand for charging.

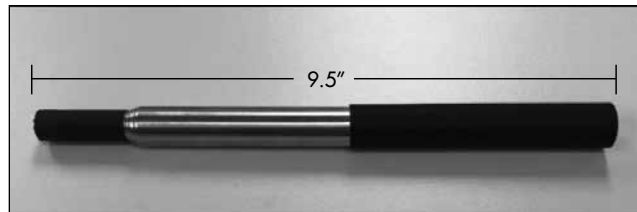

EZ Charge Wand | CKIT077
 Order with the EZ Charge Wall Mount Receiver Kit



EZ Charge Receiving Port



Port/Wand Connection

Shade/Blind Product	EZ Charge Wall Mount Receiver List Price	EZ Charge Wand List Price
---------------------	--	---------------------------

Cellular	\$18	\$32
----------	------	------



Battery Charger



Wand Base

Battery Charger - SOLD SEPARATELY

You must specify charger when ordering a Simplicity Rechargeable Motorized Shade. The charger plugs into the wand base. The 8.4 Volt charger requires a standard power outlet to recharge the motor. The charger is black and comes with a 156" wire. The dimensions are 1" wide x 2½" length x 1¾" deep.

Cellular Shade Collection

12V SIMPLICITY LOW VOLTAGE HARDWIRING SYSTEM

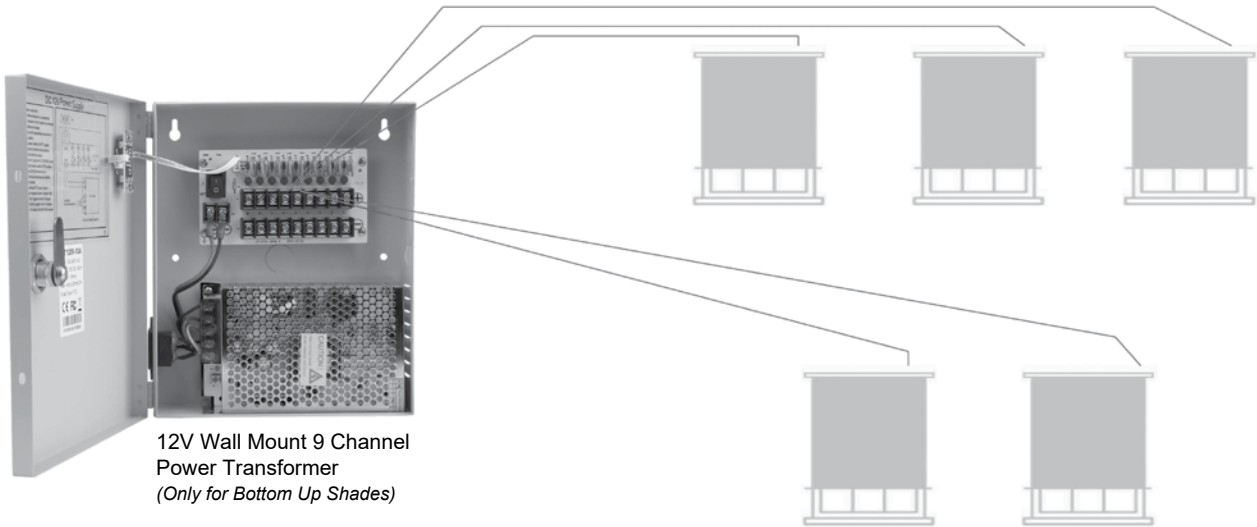

12V Low Voltage Hard Wired

Low Voltage hardwire powered motors are available for Cellular bottom up shades. The system offers a maintenance-free power option for Simplicity Motorized Shades. Our Simplicity power transformer mounts in a safe dry location (such as your basement), out of sight, and provides power for up to nine individual shades per box.

2 Conductor wires (not included) should be pre-installed by a licensed contractor according to local building codes, to connect power from the transformer to the shades.

Simply connect the wire adapters provided to connect the power wire to the Simplicity motor power input on the back of the shade, then connect the pre-run wires to the (+ / -) terminal block in the transformer box, and flip on the power switch.

- Product Dimension: 7.875" wide, 9.4" Tall, 2.45" deep
- Converts incoming 120V AC to outgoing 12V to up to 9 shades.

- **Product Description:**

- 12v10a 9ch
- Input Voltage Range : AC90V-264V
- Input Frequency Range : 50Hz-60Hz
- Output Voltage Range : DC12V+/-5%
- Output Current : 10 Ampere
- Output Power : 120 Watt
- Output Ripple&Noise : ≤42MV
- Output Efficiency : ≥83%
- Output Fuse Type : PTC
- Output Fuse Rating : 2A
- Environment Operatiing Amb.Temp : -30 ~45
20%~90%RH
- Envioment Storage Temp : -40 ~85 10%~95%RH
- Plugs into standard household outlet

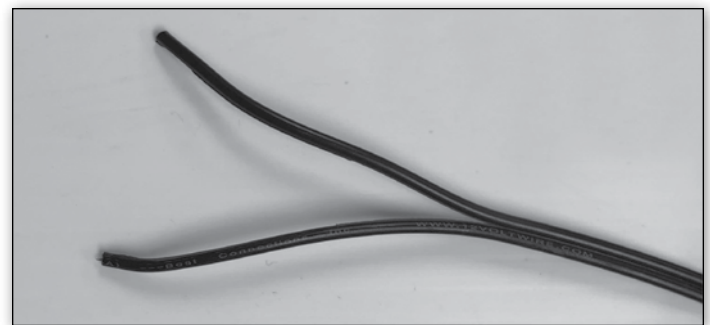

2 Conductor Wires (not included) running to basement 12V Power Transformer

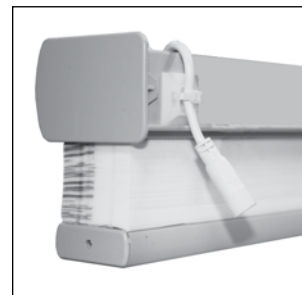

Power port on back of shade

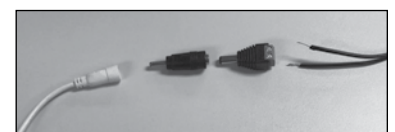

Wires connecting to power port on Simplicity shade: supplied.



12V Wall Mount 9 Channel Power Transformer

Cellular Shade Collection

SIMPLICITY SMART CONTROLLER



Simplicity Smart Controller Dimensions

- Width of controller: 2³/₈"
- Length of controller: 2¹⁵/₁₆"
- Height of controller: 1¹/₈"

Simplicity Smart Controller

- Works with Apple and Android devices
- FREE Downloadable Application
- Compatible with previously installed Simplicity Remote Control Shades
- Powered by NEO Smart Blinds App
- Compatible with Amazon Alexa, Google Assistant systems, Control4 and Savant systems

Simplicity Smart Controller

The Simplicity Smart Controller is a small device that you install in your home that allows you to set automatic opening and closing times for all Simplicity motorized shades as well as the ability to control your motorized shades from a phone, tablet or PC from anywhere in world.

The Simplicity Smart Controller will work with any Comfortex remote motorized shade with Simplicity remote control motors purchased after 2012.

The Simplicity Smart Controller plugs into a standard electrical outlet and connects to WiFi and sends signals to your shades using the same radio frequencies as a normal remote control.

How Does The NEO Smart Blinds App Work?

The app uses WiFi or cellular data to send commands over the internet to the Simplicity Smart Controller.

Do I Need Any Other Equipment?

Yes, The location where your shades are installed must have WiFi in order for the Simplicity Smart Controller to work. Additionally, you must have a smartphone or tablet running Android or iOS (eg. iPhone, iPad, Samsung Galaxy S7) and have the NEO Smart Blinds app. installed.

Why Would I Want A Simplicity Smart Controller?

There are two main ways the Simplicity Smart Controller adds additional value to your motorized shades. First, once all of your shades have been added, you can use your smartphone as a single remote for all of your shades that will work anywhere you are regardless of distance from the shade. Secondly, the device allows you to set schedules so your motorized shades automatically open and close without needing to do anything on a day to day basis.

Do I Need To Buy More Than 1 Controller?

The normal use for the Simplicity Smart Controller is to plug it in out of the way and forget it. Since it has roughly the same range as a remote you will want enough devices to allow all shades to be operated without moving the controller. So depending on the layout of the home and location of the shade, you might want multiple devices to have convenient full home coverage.

How Far Is The Range Of A Controller?

You should see a range of approximately 150 ft. However this number might be less depending on the layout of your home. In general we recommend one per a floor of a normal sized home.

Can I Control My Shades From Multiple Devices?

Yes! You can download the NEO Smart Blinds App onto multiple devices, After installing the App. on a new device simply log in with the same email/password on each device and you will have access to control your shades.

Can It Be Used With Already Installed Shades?

Yes! Simply follow the directions in the NEO Smart Blinds app. to add a shade. At the pairing step you can put the shade in pairing mode using the primary remote control (or by accessing the button on the shades motor). Adding the shade to the NEO Smart Blinds App. will not affect the normal remote operation.

How Much Does The NEO Smart Blinds App Cost?

The App is a free download, However you must have at least one Simplicity Smart Controller to serve as a bridge between the App and your shades.

Cellular Shade Collection

7.4V RECHARGEABLE POWERTOCH MOTORIZED HARDWARE SYSTEM

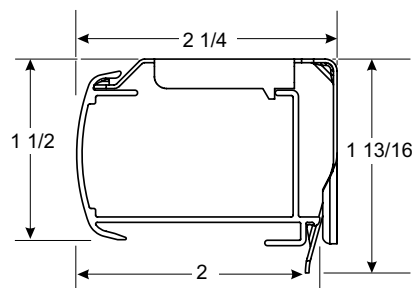
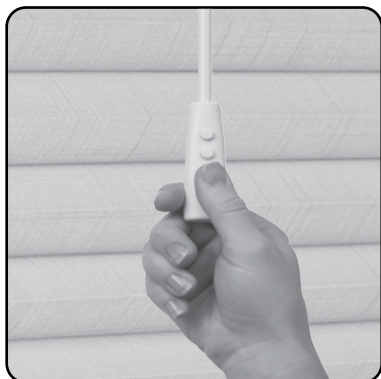
**Simplicity Motorized Rail Dimensions**

- Depth of rail: 2"
- Depth of rail and bracket: 2 1/4"
- Height of rail: 1 1/2"
- Height of bracket: 1 13/16"

Hardware Features

Hardware colors for all Cellular and Pleated fabrics	Color coordinated head, bottom rails and end caps
Standard Hardware for all Custom Graphics	White head and bottom rails and end caps
Simplicity Remote	Upper and lower limit stops pre-programmed, Intermediate stop "favorites" position can be set on site

Upgrades

Fabric Wrapped Upgrade	Fabric used is same fabric as the shade. Back of rail is white to outside. End caps on fabric wrapped head, middle and bottom rails are color coordinated
Designer Metallic Upgrade	<ul style="list-style-type: none"> • Smooth faced Oil Rubbed Bronze head, bottom rails and end caps

Mounting Dimensions**Simplicity Motorized Hardware System**

Minimum Shallow Mount	1/2"
Minimum Flush Inside Mount	2 1/4"
Minimum Outside Mount	7/8"
Minimum Side Mount	1 1/4"
Minimum Flush Side Mount	2 1/4"
Recommended Side Mounting Method	<ul style="list-style-type: none"> • See page 47 for recommended mounting method for side mount shades • Width limit for side mount brackets is 48"

Finished Dimensions**Inside Mount**

- Fabric will measure ordered width less: 3/8"
- Head rail* will measure ordered width less: 3/16"

Outside Mount

- Fabric will measure ordered width
- Head rail* will measure ordered width plus: 3/16"

Side Mount

- Fabric will measure ordered width less: 7/8"
- Head rail* will measure ordered width less: 1 1/16"

Exact (End Cap to End Cap) Mount

- Fabric will measure ordered width less: 3/16"
- Head rail* will measure ordered width

* Head rail measurements include endcaps. Width and length measurements may vary +/- 1/8"

Cellular Shade Collection

7.4V RECHARGEABLE POWERTOCH MOTORIZED HARDWARE SYSTEM

PowerTouch™ Rechargeable Shades

Cellular Shades can be fabricated with the PowerTouch Rechargeable Push Button Control option. The PowerTouch Rechargeable option is an easy, cord free motorized operation for the budget savvy homeowner. PowerTouch Rechargeable uses Simplicity motors and components.

PowerTouch Rechargeable Shades Operation

Press the up or down button on the pendant to raise or lower the shading to your desired position.

No programming is required with PowerTouch™, all programming is set at the factory. Upper and lower limits can easily be adjusted in the field if desired. Please refer to the installation instructions at comfortex.com/comfortex-dealers. A "favorites" or intermediate stop position can be set once installed.

PowerTouch Rechargeable Surcharges

See page 15.

PowerTouch Appearance

- The PowerTouch wand and pendant is attached to the head rail when installed.
- The wand and pendant hangs down the front of the shades from the head rail. The wand does not touch the fabric.
- Pendant is 2½" long.
- The pendant does not need to be mounted to the wall to operate the shade.



PowerTouch Rechargeable Color Options

- Shades with Black or Oil Rubbed Bronze hardware will be built with black wand and pendants standard. All other colors will use white wand and pendants.



White



Black Shown with Plug-In Charger

PowerTouch Wand and Pendant Location

The standard location for the wand and pendant is on the right. Please specify location when ordering.

PowerTouch Rechargeable Wand Length

- The standard length of the wand will measure the indicated below unless otherwise specified.

Shading Length	Standard Wand Length
Up to 30"	1' (12")
>30" to 52"	2' (24")
>52" to 78"	3' (36")
>78" to 100"	4' (48")
>100" to 120"	5' (60")

Mounting Requirements for PowerTouch Rechargeable Shades

- No special installation hardware or wiring requirements are needed.

Battery Charger

8.4 Volt charger requires a standard power outlet to recharge the battery. You must specify charger when ordering a Simplicity Rechargeable Shade. The charger plugs into the charger port. The charger is black and comes with a 156" wire. The dimensions are 1" wide x 2½" length x 1¾" deep.



PowerTouch Rechargeable Shades Warranty

Please see Policy PDF for complete warranty information.

Cellular Shade Collection

OVATION CELLULAR SLIDER HARDWARE SYSTEM

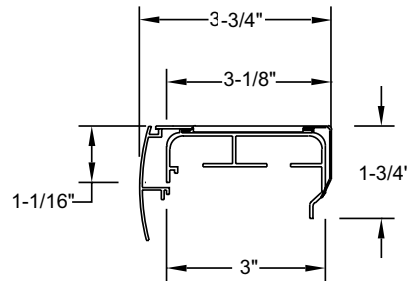

Ovation Hardware Rail Dimensions

- Depth of rail: 3"
- Depth of rail and bracket: 3 1/8"
- Depth of rail, bracket & valance: 3 3/4"
- Height: 1 3/4"

Hardware Features	
Standard Hardware Color	Aspen White #785
Optional Hardware Colors	Ivory, beige, tan and gray rails are available as an option. Visit comfortex.com to view color options <ul style="list-style-type: none"> • Gardenia White #862 • White Tierra #661 • Silverado #276
Mounting Dimensions	
	Ovation Hardware System
Minimum Inside Mount	3/4"
Minimum Flush Mount	3 5/8"
Minimum Outside Mount	5/8"
Finished Dimensions	
Inside Flush Mount	
Track Width:	
Right or Left Stack	3/16" less than ordered width
Split Stack	3/16" less than ordered width
Center Stack	3/16" less than ordered width
Finished Slider Length	1/2" less than ordered length
Valance	3/16" less than ordered width
Outside Mount	
Track Width	Ordered width
Finished Slider Length	Ordered length - No reductions will be made
Valance	Ordered width plus 1 1/4"
Valance Returns	Will measure 3 1/8" (standard)

Cellular Shade Collection

OVATION CELLULAR SLIDER HARDWARE SYSTEM

Applications

- Standard Rectangular
- Opens and closes from side to side
- Four stacking options - see below.
- Dual Panel option with a center opening design with two fabrics, one on each side, each spanning the width of the window.

Ovation Stacking Options

Specify stacking configuration when ordering.

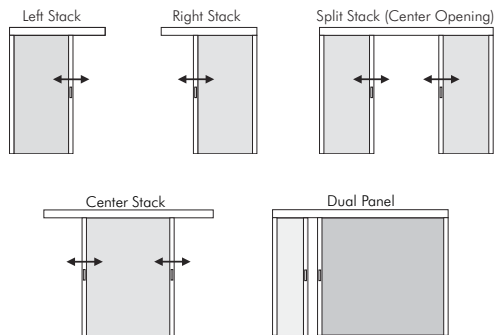

Left: Fabric stacks to the left side of the slider.

Right: Fabric stacks to the right side of the slider.

Center Stack: Center Stack Sliders fabric panels can move fully to the left or the right.

Split Stack: Fabric is split in the center of the slider forming two equal panels which open to opposite ends of the slider. Both panels will be of equal width unless otherwise specified. Split stack is not available with Gradient shades.

* Split stack sliders are available in maximum widths from 240" to 336" (maximum width depends on the fabric selected). If the width exceeds the maximum width of the fabric, it will be fabricated as two separate sliders. The supplied valance will create the appearance of a single slider. Call Customer Service for assistance.

Dual Panel: A Dual Panel Stack Slider has a center opening design with a different fabric on each side, each of which can span the full width of the window. Both panels will be of equal width unless otherwise specified. Specify which fabric stacks to left and which fabric stacks to the right.

Ordering Information for Ovation Cellular Sliders

- Specify IB or OB mount.
- Specify stacking configuration.
On Dual Panel Shades, specify which fabric stacks to the left and right.
On Split Stack Shades, both panels will be of equal width unless specified.
- Specify valance width and return length.

Ovation Valance Specifications

- Every Ovation Slider is supplied with a painted aluminum valance to match your hardware color choice.
- The valance attaches to the head rail using a durable plastic clip system.

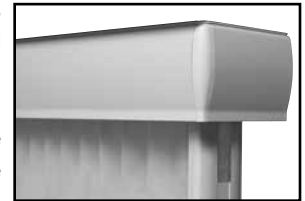

Ovation Valance Dimensions

All valance dimensions are measured on the flat, back side.

- Valance Height: 3¼"
- Standard Return Length (OB only): 3⅞"
- For each spacer block, ½" will be added to the length of the valance returns. For extension brackets, 2" will be added unless otherwise instructed.
- If the slider requires a non-flush inside mount, you must order a custom valance. Exact valance width and exact valance return length (minimum 1½") must be specified in the Special Instructions section of the order form.
- Custom returns are available for IB non-flush and OB Cellular Sliders. Please specify return length upon ordering.

Things to Consider

- Since most Ovations are sold in large sizes, the shade will have a large fabric stack. On an outside mount, you may want to order the shade a few inches wider so that the fabric stack can be clear of the window. For more information on Ovation's stack height, see pages 77-78 for information.
- Premiere Custom Design fabrics will be turned 90 degrees on Ovation Shades. The pattern orientation will be left to right since Ovation shades open side to side. Split stack is not available with Gradient shades.
- Symphony double honeycomb fabric may require additional care when opening or closing the shade. Double honeycomb fabric is generally stiffer than single honeycomb material and may offer minor resistance when opening and closing. If this is a concern, Comfortex recommends selecting a coordinating fabric from the Virtuoso or Baritone collections.

The Ultimate Blackout Cellular Shade

INSULATING SLUMBERSHADES HARDWARE SYSTEM

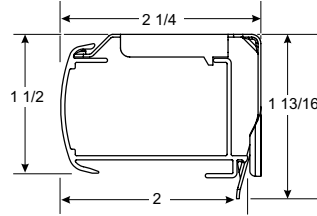

Cordless Ultra Rail

- Depth of rail: 2"
- Depth of rail and bracket: 2 1/4"
- Height of rail: 1 1/2"
- Height of bracket: 1 13/16"

Hardware Features		
Hardware colors for all Cellular fabrics	Color coordinated head, middle, bottom rails and end caps	
Blackout Sidetrack Colors Available	White, Tan and Bronze	
Upgrades		
Fabric Wrapped Upgrade	Fabric used is same fabric as the shade. Back of rail is white to outside.	
Designer Metallic Upgrade	• Oil Rubbed Bronze head, middle, bottom rails and end caps.	
Mounting Dimensions (inside mount only)	Standard Head Rail	Deluxe Head Rail
Standard Cord Lock (Standard Rectangular and Top Down-Bottom Up)		
Minimum Inside Mount	1 1/2"	1 1/2"
Minimum Flush Inside Mount	2"	2 3/8"
Cord Loop & Cordless Ultra (Standard Rectangular and Top Down-Bottom Up)		
Minimum Inside Mount	1 5/8"	NA
Minimum Flush Inside Mount	2 1/4"	NA
Outside, shallow and side mounts are not available. The shade's light blocking ability is compromised by using any other mount than a fully flush mount application.		
Finished Dimensions		
Inside Mount		
	<ul style="list-style-type: none"> • Fabric will measure ordered width less: 7/8" • Head rail and bottom rail will measure ordered width less: 1 1/16" • Sidetrack length will measure ordered length less: 1/8" 	

The widest width of the window cannot exceed the narrowest width of the window by more than 1/4".

Precise width measurements are critical to proper performance of SlumberShade products. Make sure to measure to the nearest 1/16" and provide the **NARROWEST** width measurement along the length of the window. Be sure to measure the top, middle and bottom of the opening. It is very common for the width of a window to vary from top to bottom.

The Ultimate Blackout Cellular Shade

INSULATING SLUMBERSHADES HARDWARE SYSTEM

Insulating SlumberShades Small Track Dimensions

Used with all fabrics standard size head rail.

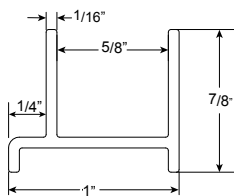

Small Track

- Width of track: 1"
- Height of track: 7/8"

Insulating SlumberShades Large Track Dimensions

Used with all fabrics that utilize the deluxe sized head rail.

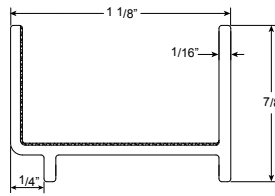

Large Track

- Width of track: 1 1/8"
- Height of track: 7/8"

Applications

- Standard Rectangular
- Top Down - Bottom Up
- Cordless and Cordless Top Down - Bottom Up
- Cord Loop and Top Down - Bottom Up
- Motorization

SlumberShades are for inside mount applications only.

Insulating SlumberShade Fabric

Light Filtering fabrics are available as SlumberShades, however the best light control is achieved by using a blackout cellular fabric.

Ordering Information for Insulating SlumberShades

SlumberShades are for inside mount applications only.

Precise width measurements are critical to proper performance of SlumberShade products. Make sure to measure to the nearest 1/16" and provide the **NARROWEST** width measurement along the length of the window. Be sure to measure the top, middle and bottom of the opening. It is very common for the width of a window to vary from top to bottom. The widest width of the window cannot exceed the narrowest width of the window by more than 1/4".

If you have questions about ordering SlumberShades, contact Comfortex Technical Services at 800-843-4151.

Accessories

- 3' Expandable Pole - Silver: (see pg 26)
- 5-10' Expandable Pole - Black:

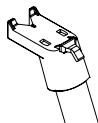

Specially designed pole end fits into the handle on the Cordless Ultra bottom rail and allows for easy operation.

Note: Pole operation with Slumbertrack can cause the rail to tilt and can make smooth operation difficult.

Insulating SlumberShades Features

Use SlumberShades to provide the darkest sleeping environment by sealing out all the light

Energy Saving Blackout Sidetracks

Energy saving blackout sidetracks are made from a durable window grade PVC. The blackout sidetracks seal off the light gap between the blackout cellular shade and the window. The blackout sidetracks feature a black interior lining to absorb light and prevent it from entering the room.



Motorization Options

Learn about the motorization options on pages 129-142.

SlumberShades are easy to install, and feature removable sidetracks that are attached to the window frame with magnets. The sidetracks can be removed for window cleaning. The UV stable, window grade PVC sidetracks are available in white, tan and bronze to match your existing trim.

Please Note: When properly installed, SlumberShades block 99% of all visible light. In certain installations with intense sunlight, a very small amount of light may reflect around the edges of the honeycomb fabric along each side of the shade. This is a normal attribute of the SlumberShade system.

Insulating SlumberShade End Caps

The specially designed notched bottom rail end caps fit over the blackout sidetracks and allow for smooth movement when raising and lowering the shade.

Head and Bottom Rail Seals

To ensure a perfectly dark sleeping environment, additional fuzz seals are supplied to be placed along the shade's bottom rail and between the head rail and the window frame if needed. These barriers provide a complete light stop all the way around the window to keep all exterior light out. Also, these additional seals provide a very effective barrier against heat loss along your windows.

Magnets and fuzz bar are standard on Cordless and Cordless Top Down-Bottom Up Shades to ensure closure between the bottom rail and window sill.

Energy Efficiency

Independent testing has shown SlumberShades provide an R-value greater than 7.0* when installed over a double paned vinyl window. The testing also indicates that the R-value of a SlumberShade is 2.5 to 3 times higher than that of the same shade without sidetracks. The insulating cellular fabric, sidetracks, and fuzzy seal all ensure that the SlumberShades provides superior energy efficiency.

* Independent testing provided by Consortium for Advanced Residential Buildings (CARB), a U.S. Department of Energy Building America research team. Learn more at comfortex.com/comfortex-dealers.

EZ Level

Learn about the EZ Level feature on page 91.

Cellular Specialty Shades

STARBURST ARCHES HARDWARE SYSTEM

Stationary Starburst

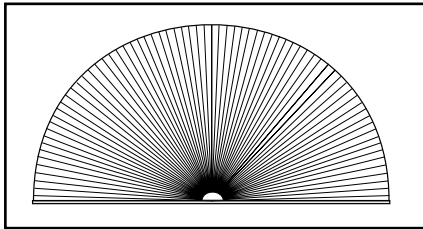

Figure A

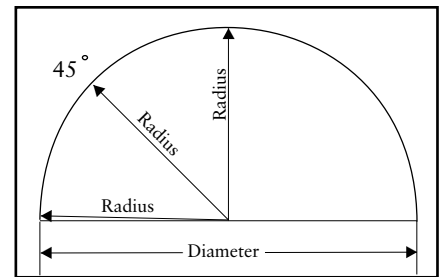

Figure C

Hardware Features See Page 46 for Rail Dimensions		
Hardware colors	Color coordinated rails	
Upgrades		
Fabric Wrapped Upgrade	Fabric used is same fabric as the shade. Back of rail is white to outside. Color coordinated end caps. Please note: On Stationary Starburst Arches the fabric wrap will be spliced in the center of the base rail.	
Designer Metallic Upgrade	<ul style="list-style-type: none"> Oil Rubbed Bronze rails with bronze colored end caps. 	
Mounting Dimensions		
	Standard Cord Lock Rail	Deluxe Cord Lock Rail
Minimum Shallow Mount	3/4"	3/4"
Minimum Flush Inside Mount	2"	2 3/8"
Recommended Side Mounting Method	<ul style="list-style-type: none"> See page 47 figure B for recommended mounting method for side mount shades Width limit for side mount brackets is 48" 	
Finished Dimensions		
Inside and Side Mount		
<ul style="list-style-type: none"> Fabric will measure ordered width less: 3/8" Head rail* will measure ordered width less: 3/16" 	<ul style="list-style-type: none"> * Head rail measurements include endcaps. Width and length measurements may vary +/- 1/8" 	

Applications

- Stationary Fan Style Arch

Stationary Starburst Features (Figure A)

- All non-perfect Stationary Starburst arches require a template made from brown craft paper.** Comfortex offers template kits. Please contact Customer Service to order. Stock number: 751000, See page 92
- A perfect arch is twice as wide as it is high.
- Stationary Starburst shades which are not perfect half circles must have a height that equals half the width +/- 5".
- Price according to the largest radius measurement. If the height is greater than the width, take height X 2 and use that number to determine pricing.
- When ordering arches as perfect half-circles make sure the radius of the arch remains constant to ensure a proper fit. (See Figure C)

Accessories

- 5-10' Expandable Pole - Black
- Specially designed pole end fits into the handle on movable Starburst Shades for easy operation.



Not Offered as of April 21, 2024

Cellular Specialty Shades
SUNSET ARCHES HARDWARE SYSTEM

Not Offered as of April 21, 2024

Cellular Specialty Shades

QUARTER ROUNDS HARDWARE SYSTEM

Movable Quarter Round

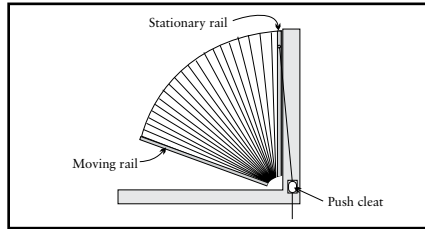

Figure A

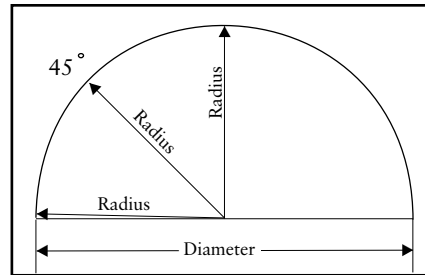

Figure B

Stationary Quarter Round

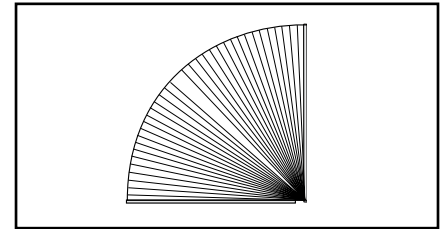

Figure C

Hardware Features | See Page 46 for Rail Dimensions

Hardware colors for all Cellular fabrics	Color coordinated rails with white cord and tassel
--	--

Upgrades

Fabric Wrapped Upgrade	Fabric used is same fabric as the shade. Back of rail is white to outside. Color coordinated end caps.
Designer Metallic Upgrade	<ul style="list-style-type: none"> Oil Rubbed Bronze rails and endcaps, bronze colored tassel and white cord.

Mounting Dimensions

	Standard Rail	Deluxe Rail
Minimum Shallow Mount	3/4"	3/4"
Minimum Flush Inside Mount	2"	2 3/8"
Minimum Outside Mount	3/4"	3/4"
Minimum Side Mount	1 1/8"	1 3/8"
Minimum Flush Side Mount	1 5/8"	1 7/8"

Recommended Side Mounting Method • See page 70 figure F for recommended mounting method for side mount shades

Finished Dimensions

Inside and Side Mount

- Fabric will measure ordered width less: 3/8"
- Head rail* will measure ordered width less: 3/16"

Outside Mount

- Fabric will measure ordered width
- Head rail* will measure ordered width plus: 3/16"

Exact (End Cap to End Cap) Mount

- Fabric will measure ordered width less: 3/16"
- Head rail* will measure ordered width

* Head rail measurements include endcaps. Width and length measurements may vary +/- 1/8"

Applications

- Stationary Fan Style Quarter Round
- Movable Fan Style Quarter Round

Accessories

- 5-10' Expandable Pole - Black



Specially designed pole end fits into the handle on movable Quarter Round Shades for easy operation.

Ordering Information for Quarter Rounds Shades

- Specify IB or OB mount and rail color.
- Include a template if the shade is a non-perfect quarter round.

Cellular Specialty Shades

QUARTER ROUNDS HARDWARE SYSTEM

Quarter Rounds Features (Figure A) pg 71

All Quarter Round Shades which are not perfect quarter circles require a template. Price according to the largest radius measurement.

- See page 93 for template instructions.
- **All templates should be made from brown craft paper.** Comfortex offers template kits. Please contact Customer Service to order. Stock number: 751000
- The horizontal (moving) rail of a Movable Quarter Round shade **must be smaller** than the vertical (stationary) rail to allow clearance for the moving rail. The shade will stack in the vertical position.
- When ordering arches as perfect quarter circles, make sure the radius of the arch remains constant to ensure a proper fit. (See Figure B) pg 71



Operation

Moveable Quarter Round

Pull the cord down to bring the shade to a stacked position.

The shade stacks against the vertical rail.

Push the button in on the cord cleat to release the cord and lower the shade across the window.

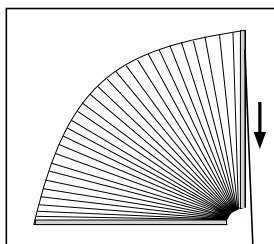

WARNING: To avoid possible strangulation, keep cords out of reach of children.

Cellular Specialty Shades

TRAPEZOIDS AND OCTAGONS HARDWARE SYSTEM

Movable Trapezoids

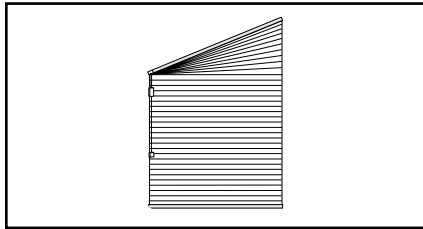

Movable Octagons

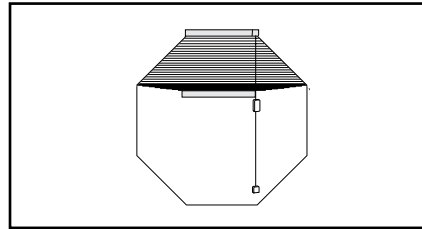

Hardware Features See Page 46 for Rail Dimensions		
Hardware colors for all Cellular fabrics	Color coordinated head and bottom rails with white cord and tassel	
Upgrades		
Fabric Wrapped Upgrade	Fabric used is same fabric as the shade. Back of rail is white to outside. Color coordinated end caps.	
Designer Metallic Upgrade	• Oil Rubbed Bronze head and bottom rails with bronze colored tassel, end caps and white cord.	
Mounting Dimensions		
	Standard Cord Lock Rail	Deluxe Cord Lock Rail
Minimum Shallow Mount	3/4"	3/4"
Minimum Flush Inside Mount	2"	2 3/8"
Minimum Outside Mount	3/4"	3/4"
Minimum Side Mount	1 1/8"	1 3/8"
Minimum Flush Side Mount	1 5/8"	1 7/8"
Recommended Side Mounting Method	• See page 47 for recommended mounting method for side mount shades	
Finished Dimensions		
Inside and Side Mount		
	<ul style="list-style-type: none"> • Fabric will measure ordered width less: 3/8" • Head rail* will measure ordered width less: 3/16" 	
Outside Mount		
	<ul style="list-style-type: none"> • Fabric will measure ordered width • Head rail* will measure ordered width plus: 3/16" 	
Exact (End Cap to End Cap) Mount		
	<ul style="list-style-type: none"> • Fabric will measure ordered width less: 3/16" • Head rail* will measure ordered width 	
* Head rail measurements include endcaps. Width and length measurements may vary +/- 1/8"		

Applications

- Movable Trapezoids
- Movable Octagons

Ordering Information for Trapezoid Shades

- Specify IB or OB mount and rail color.
- **Trapezoid orders must be faxed or emailed in with a diagram. Please provide measurements for all four sides when ordering. No template is required.**

Ordering Information for Octagon Shades

- Specify IB or OB mount and rail color.
- **Octagon Shades do not require a template. The width, length and one side are required measurements when ordering.**

Cellular Specialty Shades

TRAPEZOIDS AND OCTAGONS HARDWARE SYSTEM

Trapezoids (Figure A)

- **Trapezoid orders must be faxed in with a diagram. Please provide measurements for all four sides when ordering. No template is required.**
- The maximum slope of the top rail is 30 degrees from horizontal. Slope is the angle between slope and a horizontal line. The slope angle must be measured with a protractor.
- Sides of trapezoid must be parallel.
- Sill must be level for proper installation and operation of a trapezoid shade.
- Operating cord must be placed on the short side.
- See Figures B and C for trapezoid shade operation.

Octagons

- **Octagon Shades do not require a template.**
- **The width, length and one side are required measurements when ordering.**
- Octagon shades raise only to the point where the top angle begins. (See Figure D)
- See Figure F on page 70 for recommend mounting method for side mount shades.

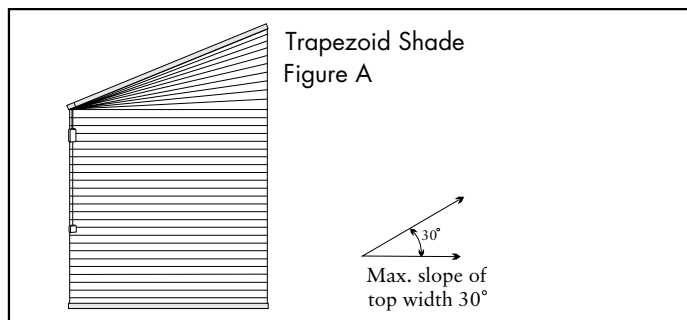

Trapezoid Shade Operation

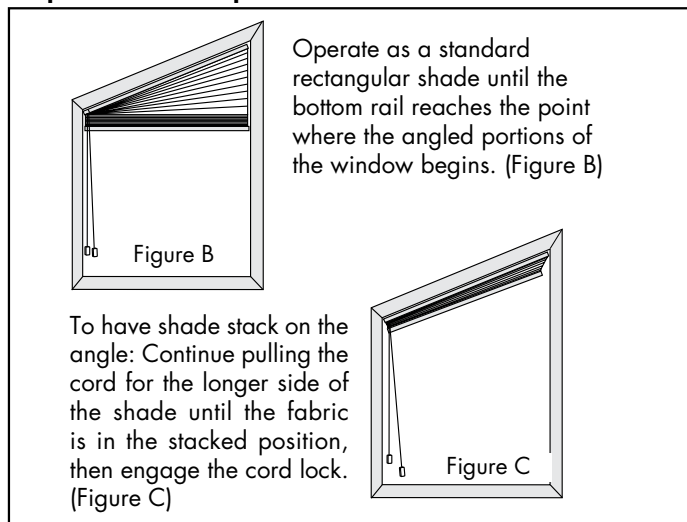

Octagon Operation

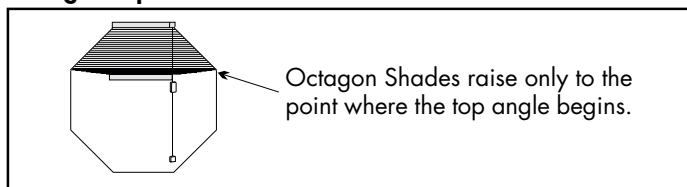
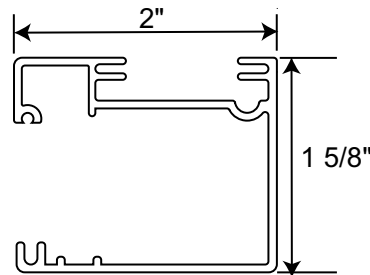

Figure D

Cellular Specialty Shades

SOPRANO SKYLIGHTS AND GREENHOUSE SHADES HARDWARE SYSTEM

**Soprano Rail Dimensions**

- Depth of rail: 2"
- Height of rail: 1 5/8"

Hardware Features		
Hardware colors	• White head, bottom rail with white gear track retainer.	
Mounting Dimensions	Soprano Skylights and Greenhouse Shades	
Minimum depth required for installation	1 1/2"	
Minimum Flush Inside Mount (Rail Fully Recessed)	2 3/8"	
Minimum Flush Inside Mount (Handle Fully Recessed)	3"	
Deductions		
	Total deduction on the bottom moving rail is 3/4"	
	Total deduction on the top rail is 1 1/2"	
Finished Dimensions	Symphony & Debut 1/2"	All Other Fabrics
Inside Mount		
	• Fabric will measure ordered width less: 3/8"	1 1/2"
	• Head rail* will measure ordered width less: 3/16"	1 5/16"
* Head rail measurements include endcaps. Width and length measurements may vary +/- 1/8"		

Applications

- Soprano Skylights
- Soprano Greenhouses

Soprano Shades are for inside mount applications only.

Ordering Information for Soprano Skylights and Greenhouse Shades

- White Rails.
- For Greenhouse Shades, supply measurements for: straight top section, curved section and vertical straight section when ordering.

Accessories

- Two Moving Rails*
- 5-10' Expandable Pole - Black

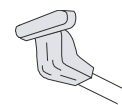

Specially designed pole end fits into the handle of Soprano shades for easy operation at any angle.

*This option allows you to move shade up from the bottom or down from the top. For ultimate control of light and privacy. See page 83 for upgrade pricing.

Skylight Installation Angles

- For inside mount applications on straight (planar) runs.
- Minimum Installation angle of 5 degrees.
- Maximum installation angle of 85 degrees.
- Horizontal (0 degrees) and vertical (90 degrees) applications are not recommended.

Cellular Specialty Shades

SOPRANO SKYLIGHTS AND GREENHOUSE SHADES HARDWARE SYSTEM

Soprano Skylight Features (Figure A)

- Soprano Shades feature a polycarbonate track system. The hidden gear track allows for smooth operation of the shade and controls light.
- The gear track retainer is White to match the moving bottom rail.

Soprano Greenhouse Shades Features (Figure B)

- See Figure C below for Greenhouse shade ordering information.
- Soprano Shades are for inside mount applications only.
- **All greenhouse orders require a completed and signed greenhouse shade order form.** Orders must be mailed or faxed to Comfortex for processing. Download a copy at www.comfortex.com/comfortex-dealers or from the OnDemand Library Mobile Library.
- Soprano Shades feature a polycarbonate track system. The hidden gear track allows for smooth operation of the shade and controls light.
- The gear track retainer is White to match the moving bottom rail.

Soprano Skylights

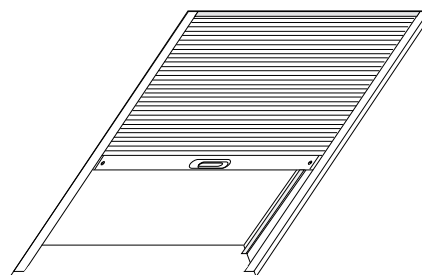

Figure A

Soprano Greenhouses

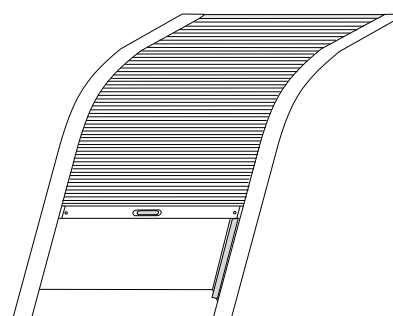
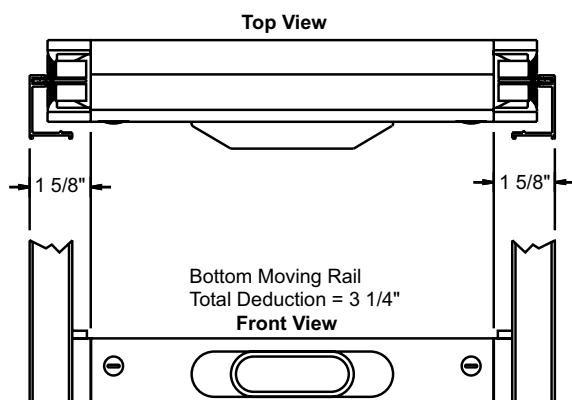
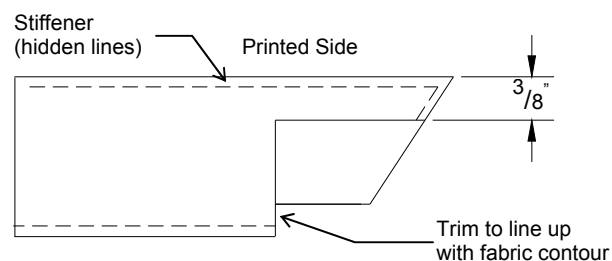

Figure B



Soprano Skylights and Greenhouses Moving Rail
Top and Front View

Soprano Fabric Notch for small pleat fabric



Additional trimming for bottom stiffener
(and attached single layer of fabric).

Greenhouse Ordering Information Figure C

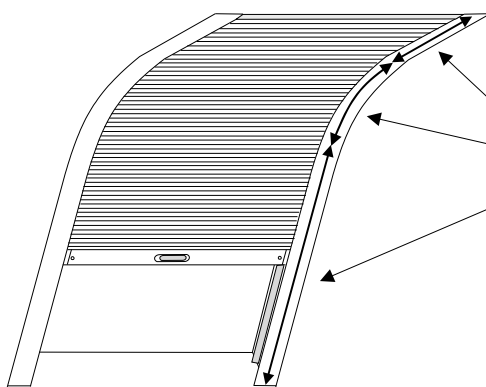

The side rails for greenhouse shades are notched at the curve in the factory. Please supply measurements for:
Straight top section,
Curved section and
Vertical straight section when ordering.

Cellular Specialty Shades

BALCONY SHADING HARDWARE SYSTEM

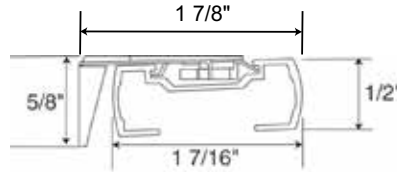
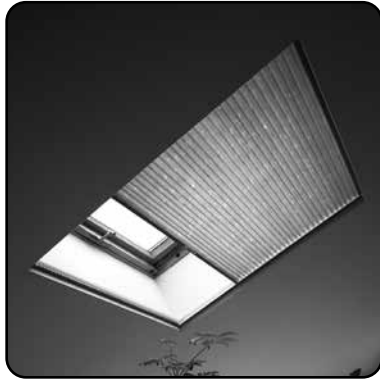

Balcony Rail Dimensions

- Depth of rail: 1 7/8"
- Depth of rail and bracket: 1 7/8"
- Height of rail: 1/2"

Hardware Features	
Hardware colors for all fabrics	Color coordinated head and bottom rails with white cord in a white sidetrack.
Upgrades	
Fabric Wrapped Upgrade	Fabric wrapped head and bottom rails. Fabric used is same fabric as the shade. Back of rail is white to outside.
Designer Metallic Upgrade	<ul style="list-style-type: none"> • Designer Oil Rubbed Bronze head and bottom rails with white cord in a white sidetrack. • Designer Brushed Nickel head and bottom rails with white cord in a white sidetrack.
Mounting Dimensions - Inside Only	
Balcony Shading System	
Minimum required for installation	1 1/4"
Minimum Flush Inside Mount (Rail Fully Recessed)	2 1/4"
Minimum Flush Inside Mount (Handle Fully Recessed)	2 1/16"
The widest width of the window cannot exceed the narrowest width of the window by more than 3/8".	
Finished Dimensions	
Inside Mount	
	<ul style="list-style-type: none"> • Fabric will measure ordered width less: 1" • Head rail* will measure ordered width less: 3/16"
* Head rail measurements include endcaps. Width and length measurements may vary +/- 1/8"	

Applications

- Horizontal, Angled and Vertical rectangular windows and skylights. Balcony Shading Systems are for inside mount applications only.

Ordering Information for Balcony Shading System

- Specify rail color.
- Specify when ordering: Application angle: Angled, Horizontal or Vertical.

Accessories

- 3' Expandable Pole - Silver (see pg 26)
- 5-10' Expandable Pole - Black



Specially designed pole end fits into the handle of Balcony shades for easy operation at any angle.

Cellular Specialty Shades

BALCONY SHADING HARDWARE SYSTEM

Balcony Shading System Features

- Balcony Shades work in three orientations applications: Angled, Horizontal and Vertical.
Horizontal works on slope angles 0 to 15 degrees.
Angled works on slope angles 15 to 75 degrees.
Vertical works on slope angles 75 to 90 degrees.
- Balcony shades can be mounted on their side. (See Figure A). Use the vertical measurement as your width (max. 36") and the horizontal measurement as your length (max. 48").
- Polycarbonate track system provides superior insulation and light blocking. The enclosed sides provide full privacy.
- No exposed cords, eliminates risk of injury to children.

Balcony Vertical Applications

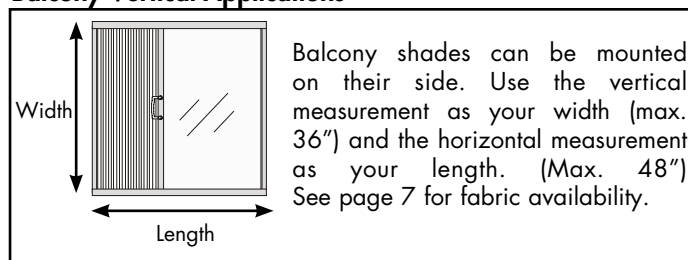

Figure A

Maximum Shade Area

Maximum shade areas (in square feet) varies with slope and fabric type.

	Horizontal	Angled	Vertical
Symphony (All)	24	24	18
Debut Light Filtering (All)	24	24	18
Virtuoso (All)	24	24	18



Cellular Specialty Shades

7.4V MEZZO RECHARGEABLE MOTORIZED SKYLIGHT HARDWARE SYSTEM

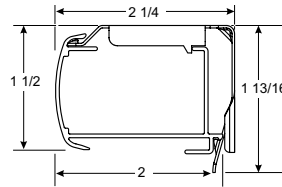

Simplicity Motorized Rail Dimensions

- Depth of rail: 2"
- Depth of rail and bracket: 2 1/4"
- Height of rail: 1 1/2"
- Height of bracket: 1 13/16"

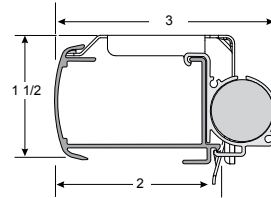

Simplicity Motorized Rail with External Battery Dimensions (shades under 20")

- Depth of rail: 2"
- Depth of rail, bracket & battery: 3"
- Height of rail: 1 1/2"
- Height of bracket: 1 13/16"

Mezzo Motorized Skylight Shades are designed for fabric to stack at the top only.

Hardware Features	
Hardware colors	White head, bottom and side rails
Simplicity Remotes	Upper and lower limit stops pre-programmed, Intermediate stop "favorites" position can be programmed on-site, 14 Channel remote options
Mounting Dimensions	
	Mezzo Motorized Skylight Shades
Minimum Flush Inside Mount	2 1/2"
	<ul style="list-style-type: none"> • Should not be more than 1/2" out of square to perform as intended • The widest width of the window cannot exceed the narrowest width of the window by more than 3/8". • The shade must be mounted with the fabric stack at the top of the window
	See page 80 for Solar Panel Mounting information.
Finished Dimensions	
Inside Mount	
	<ul style="list-style-type: none"> • Fabric will measure ordered width less: 1 1/4" • Head rail* will measure ordered width less: 3/16"
* Head rail measurements include endcaps. Width and length measurements may vary +/- 1/8"	
MOTORIZATION - HARDWARE UPGRADE SURCHARGES AND ACCESSORIES All standard discounts apply to motorized shades	
	ADD
Simplicity - Motor and Battery Wand	\$300
Simplicity 14 Channel White Remote	\$50
48" Extension Wire:	\$10
Simplicity Smart Controller (NEO)	\$280
7.4v Solar Panel & Mounting Brackets	\$120

Front Access Control

All Mezzo Shades with Rechargeable Simplicity motors come with a front-facing, flip-top cover for convenient access to the charging port, reset button, and on/off switch.

More information and pictures on page 81.

Ordering Information for Mezzo Motorized Skylight Shades

- Specify inside mount dimensions.
- Specify fabric color and style.
- Specify remote and other accessories if needed.

Cellular Specialty Shades

7.4V MEZZO RECHARGEABLE MOTORIZED SKYLIGHT HARDWARE SYSTEM _____

Applications

- Angled and Vertical motorized skylight shades.
- Mezzo Motorized Skylight Shades are for inside mount applications only.
- Skylights with Simplicity motorization will not operate properly if installed in a completely horizontal application. The minimum recommended slope is 5 degrees.
- Must be mounted with fabric stack at top.

RECHARGEABLE SIMPLICITY MOTORS

The Simplicity Motor program features a battery powered motor utilizing a rechargeable battery hidden inside the shade head rail. Simplicity motors are compact and use a radio frequency remote to raise or lower the shades.

Simplicity Rechargeable Battery

The rechargeable battery is concealed in the head rail of the shade. A charger is required for the rechargeable battery. The rechargeable battery comes fully charged from the factory.

Shades with width of 18"- 20" require the battery wand to be mounted externally.



Charging Port on Back of Head rail.

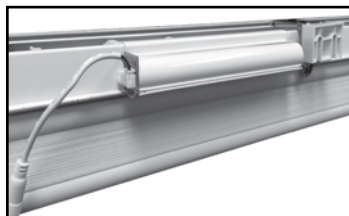

Snap-On external battery for Mezzo shades under 20" in width.

Top Down-Bottom Up Simplicity Motor Hand Held 14 Channel Remote

The TDBU remote has 14-channels. Each channel has a setting able to operate the middle rail and a setting able to operate the bottom rail. The TDBU remote is required for TDBU motors, but can be used with other motors as well. The **14 Channel TDBU remote** can operate up to fourteen shades individually or 14 groups. Simplicity Rechargeable Motorized Cellular Shades are programmed at the factory with the "up and down" limits. The shades are **UNLINKED** from the remote so they are not able to operate during shipping. Each shade should be installed **after** linking it to the remote.

Simplicity TDBU remotes and holders are white in color. The remote comes with a holder which can be mounted to a wall for easy storage. The range of the remote is approximately 80 feet. A **14 Channel (14C) remote** can be utilized on all Simplicity motorized shades.



Solar Panel Recharge Option

Plugs in to any Simplicity Rechargeable Remote control shade (does not work with PowerTouch)

Provides constant trickle charge to 7.4v Li-Ion Rechargeable battery packs. Will prolong the life of the charge of the 7.4v rechargeable battery packs, and in some applications will maintain charge indefinitely.

Life of charge is subject to application variables such as, size and weight of shade, frequency of use, amount of direct sunlight exposure, etc.

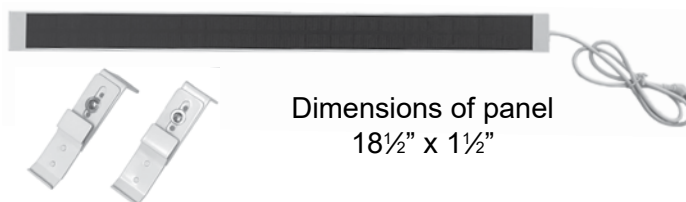

Dimensions of panel
18½" x 1½"

- Solar Panel with Mounting Brackets: \$120.00

Solar Recharge Optimum Application

- Full direct sunlight (minimum 2 hours per day) to maintain full charge. Based on one operation cycle per day (one open, one close).
- Excessive duration of cloudy weather will impact the rate of charge.
- Avoid any obstructions including mullions and screens.

Solar Panel Mounting

Bottom portion of the bracket may be lowered if needed for more sun exposure. Bracket can be mounted behind or next to shade mounting bracket.

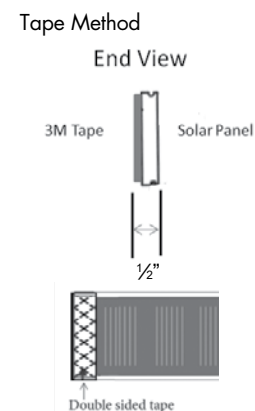
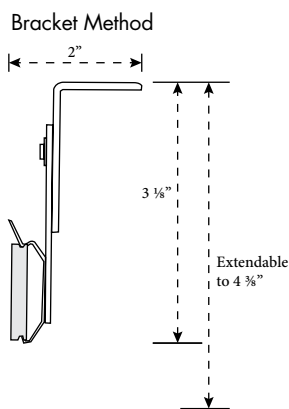

Tape goes on the face (black side) of the panel.

If the solar panel is mounted directly behind the headrail at the top of the window, you need to make sure that the solar panel does not interfere with the shade mounting brackets also. The solar panel can go between brackets spaced apart, or behind brackets if the depth of the window casing allows.

Cellular Specialty Shades

7.4V MEZZO RECHARGEABLE MOTORIZED SKYLIGHT HARDWARE SYSTEM _____

**Battery Charger**

8.4 Volt charger requires a standard power outlet to recharge the battery. You must specify charger when ordering a Simplicity Rechargeable Shade. The charger plugs into the charger port. The charger is black and comes with a 156" wire. The dimensions are 1" wide x 2½" length x 1¾" deep.

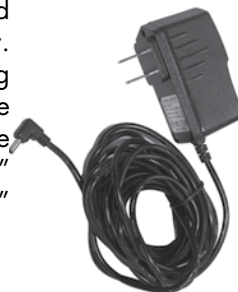
**Important Simplicity Motorized Shades Operating and Installation Information**

- Simplicity Motorized Shades installed into windows with metal casings may have a reduced radio frequency range, or may not operate at all, depending on the application.
- Do not let the antenna on the motor touch any metal objects. This may interfere with signals from the remote control.

Front Access Control

All Mezzo Shades with Rechargeable Simplicity motors come with a front-facing, flip-top cover for convenient access to the charging port, reset button, and on/off switch.

Shades with front control access include an auxiliary charging port in the back. This port is ideal for a solar panel charging kit or for shades where a top treatment may limit access to the front-side port.

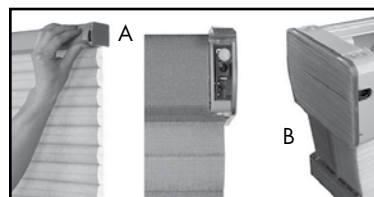

A) Front Control

B) Back of Head rail.

Cellular Specialty Shades

FRENCH DOOR DÉCOR HARDWARE SYSTEM



Standard Head Rail

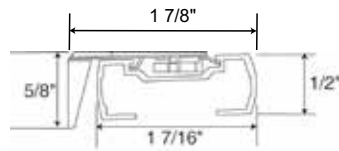

Deluxe Head Rail

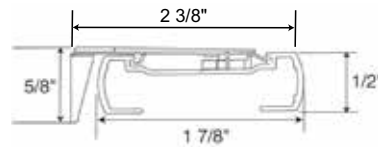

Standard Rail

- Depth of rail: 1 7/16"
- Depth of rail and bracket: 1 7/8"
- Height of rail: 1/2"
- Height of bracket: 5/8"

Deluxe Rail

- Depth of rail: 1 7/8"
- Depth of rail and bracket: 2 3/8"
- Height: 1/2"
- Height of bracket: 5/8"

Hardware Features	
Hardware colors	Color coordinated head, middle, bottom rails and end caps
Upgrades	
Fabric Wrapped Upgrade	Fabric used is same fabric as the shade. Back of rail is white to outside. Color coordinated end caps
Designer Metallic Upgrade	<ul style="list-style-type: none"> • Oil Rubbed Bronze head, middle, bottom rails and end caps.

Mounting Dimensions	Standard Rail	Deluxe Rail
Minimum Shallow Mount	3/4"	3/4"
Minimum Flush Inside Mount	2"	2 1/2"
Minimum Flush Inside Mount (Handle Fully Recessed)	2 9/16"	3"
Minimum Outside Mount	3/4"	3/4"
Minimum Side Mount	1 1/8"	1 3/8"

The widest width of the window cannot exceed the narrowest width of the window by more than 3/8".

Recommended Side Mounting Method	<ul style="list-style-type: none"> • See page 47 for recommended mounting method for side mount shades • Width limit for side mount brackets is 48"
---	---

Finished Dimensions

Inside and Side Mount	
	<ul style="list-style-type: none"> • Fabric will measure ordered width less: 3/8" • Head rail* will measure ordered width less: 3/16"
Outside Mount	
	<ul style="list-style-type: none"> • Fabric will measure ordered width • Head rail* will measure ordered width plus: 3/16"
Exact (End Cap to End Cap) Mount	
	<ul style="list-style-type: none"> • Fabric will measure ordered width less: 3/16" • Head rail* will measure ordered width

* Head rail measurements include endcaps. Width and length measurements may vary +/- 1/8"

Cellular Specialty Shades

FRENCH DOOR DÉCOR HARDWARE SYSTEM

Applications

- Stationary Door Décor
- Movable Door Décor
- Top Down - Bottom Up Door Décor
- Cover french doors, transoms, and side lights.

French Door Décor Hardware Features

- Features two non-moving rails which are mounted in the window or door. A tension control system enables the movable rail to be easily moved with the touch of a finger. The only visible cords are the ones that hold the movable middle rail in place.
- The widest width of the window cannot exceed the narrowest width of the window by more than $\frac{3}{8}$ ".

Stationary Non-Movable French Door Décor Shades

- Top and bottom rails are mounted to the window and are stationary.

Movable French Door Décor Shades

- Top and bottom rails are mounted to the window, one middle movable rail raises from the bottom.

Top Down - Bottom Up Option

- Top and bottom rails are mounted to the window, two movable rails allow the shade to lower from the top and raise from the bottom.
- The non-movable top and bottom rails are attached to the window or door.
- Ideal for entry ways with narrow windows next to doors and other narrow windows that are easily accessible.

Ordering Information for French Door Décor

- Specify IB or OB mount and rail color.
- Specify stationary, movable or Top Down - Bottom Up.

French Door Decor Cellular Shades Hardware

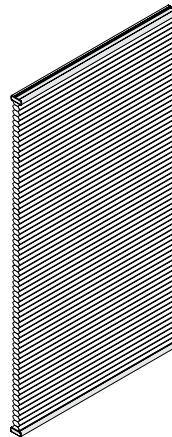

Stationary Non-Movable

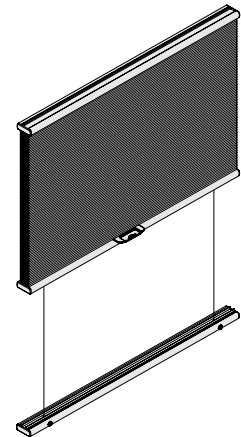

Shown open with movable rail option

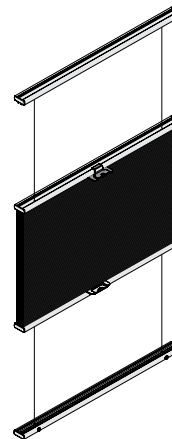

Shown open with Top Down - Bottom Up Option

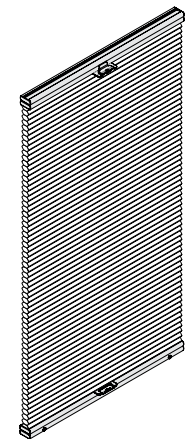

Shown closed with Top Down - Bottom Up Option

Cellular Specialty Shades

DAY-NIGHT SHADES HARDWARE SYSTEM



Standard Cord Lock Rail

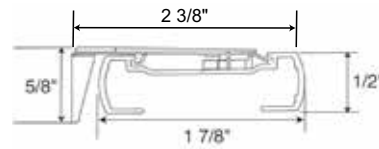
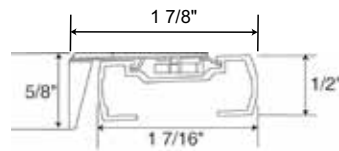

Standard Cord Lock Rail

- Depth of rail: 1 7/16"
- Depth of rail and bracket: 1 7/8"
- Height of rail: 1/2"
- Height of bracket: 5/8"

Deluxe Cord Lock Rail

- Depth of rail: 1 7/8"
- Depth of rail and bracket: 2 3/8"
- Height: 1/2"
- Height of bracket: 5/8"

Hardware Features		
Hardware colors for all Cellular fabrics	Color coordinated head, middle and bottom rails with white cord and tassel. See additional details on page 85.	
Upgrades		
Fabric Wrapped Upgrade	Fabric used is same fabric as the shade. Back of rail is white to outside. Color coordinated end caps.	
Designer Metallic Upgrade	<ul style="list-style-type: none"> • Oil Rubbed Bronze head and bottom rails with bronze colored tassel, end caps and white cord. 	
Mounting Dimensions		
	Standard Rail	Deluxe Rail
Minimum Shallow Mount	3/4"	3/4"
Minimum Flush Inside Mount	2"	2 3/8"
Minimum Outside Mount	3/4"	3/4"
Minimum Side Mount	1 1/8"	1 3/8"
Recommended Side Mounting Method	<ul style="list-style-type: none"> • See page 47 for recommended mounting method for side mount shades • Width limit for side mount brackets is 48" 	
Finished Dimensions		
Inside and Side Mount		
	<ul style="list-style-type: none"> • Fabric will measure ordered width less: 3/8" • Head rail* will measure ordered width less: 3/16" 	
Outside Mount		
	<ul style="list-style-type: none"> • Fabric will measure ordered width • Head rail* will measure ordered width plus: 3/16" 	
Exact (End Cap to End Cap) Mount		
	<ul style="list-style-type: none"> • Fabric will measure ordered width less: 3/16" • Head rail* will measure ordered width 	
* Head rail measurements include endcaps. Width and length measurements may vary +/- 1/8"		

Applications

- Standard Rectangular with cellular fabrics only.

Day - Night Shade Specifications

Refer to the appropriate fabric sections for proper pricing.

Fabrics

- Some fabrics (i.e. Symphony Blackout) can be used exclusively only as a bottom panel only.

Cellular Specialty Shades

DAY-NIGHT SHADES HARDWARE SYSTEM

Rail Colors and Cord Colors

- **Color Coordinated Rail Shades:** The top rail and middle rail will coordinate with top fabric and bottom rail will coordinate with the bottom fabric. The cord and tassel will be white. Not available with Color Lux Shades.
- **Designer Metallic Hardware Shades:** All rails, end caps and tassels will be the selected metallic color. Cords will be white.
- **Fabric Wrapped Rail Shades:** The top rail and middle rail will coordinate with top fabric and bottom rail will coordinate with the bottom fabric. The cord and tassel will be white. End caps and cord lock will be color coordinated.

Ordering Information for Day - Night Shade

- Specify fabrics, top and bottom panels.
- Specify IB or OB mount and rail color.

TOP FABRIC

CELLULAR	Width		Length	
	Min	Max	Min	Max
Verona	12"	72"	18"	96"
Boutique	12"	72"	18"	96"
Debut 1/2" Double Cell Light Filtering	12"	72"	18"	96"
Debut 1/2" Single Cell Light Filtering	12"	72"	18"	96"
Debut 3/4" Single Cell Light Filtering	12"	72"	18"	96"
Linen Weave Light Filtering*	12"	72"	18"	96"
Linen Weave Room Darkening*	NA	NA	NA	NA
Premiere 1/2" Single Cell Blackout	NA	NA	NA	NA
Premiere 1/2" Single Cell Light Filtering	12"	72"	18"	96"
Premiere 3/4" Single Cell Blackout	NA	NA	NA	NA
Premiere 3/4" Single Cell Light Filtering	12"	72"	18"	96"
Aspen 3/8" Double Cell Light Filtering	12"	72"	18"	96"
Symphony 3/8" Double Cell Blackout	NA	NA	NA	NA
Symphony 3/8" Double Cell Light Filtering	12"	72"	18"	96"

BOTTOM FABRIC

Width		Length	
Min	Max	Min	Max
12"	72"	18"	96"
12"	72"	18"	96"
12"	72"	18"	96"
12"	72"	18"	96"
12"	72"	18"	96"
12"	72"	18"	96"
12"	72"	18"	96"
12"	72"	18"	96"
12"	72"	18"	96"
12"	72"	18"	96"
12"	72"	18"	96"
12"	72"	18"	96"
12"	72"	18"	96"
12"	72"	18"	96"

* Day-Night Shades can only be built in conjunction with other 3/4" cellular fabrics. All Debut includes print patterns: Strie, Terazzo, Angel Hair, Strat, Florance, Blossom, Country Woven and Homespun.

COMFOTEX CUSTOM GRAPHIC SHADES



Comfortex
WINDOW FASHIONS

Custom Graphic Shades

CELLULAR SHADE FEATURES & GENERAL INFORMATION

Custom Graphics

With Custom Graphics, you can print anything on a Cellular Shade. From logos to personal photos, theme room graphics or advertising for your storefront, anything you envision can be featured on a Custom Graphics Cellular Shade.

Hardware | Mounting | Finished Dimensions

[See Page 45](#)

Available Fabrics

Custom Graphics are available with the following fabrics:

- Premiere ½" and ¾" Light Filtering Fabrics
- Premiere ½" and ¾" Blackout Fabrics

Custom Graphics can work for any window.

Advertising and Store Identification

Contact local businesses and explain how you can turn their window space into advertising!



Decorative and Personal Photos

Customers can now convert their special photos into a highly personalized room!

Printing Information and Options

Custom Graphics will look different from fabric to fabric. The color vibrancy on cellular shades will be muted due to the density of the fabrics and the printing process.

To view examples on Cellular Shades, visit the Custom Graphic section of the Comfortex website.

Single Sided Printing:

Cellular Custom Graphics are available as single-sided only. Double-sided graphics are not available.

You can choose to have Side A face the room side or the street side.



Side A
Shows Printed Image



Side B
White Fabric

Ordering Information for Custom Graphics Cellular Shades

Step 1. Fill out the Custom Graphics Cellular Shades

Order Form. This form includes your fabric and hardware selections. Fax the completed order form to (800) 336-4580 to place your order.

Custom Graphic orders can only be placed by faxing this form.

Step 2. Receive your Comfortex Work Order Confirmation number. Be sure to reference this number when submitting you artwork in Step 3.

Step 3. Send your graphic files via email to:
CustomGraphics@Comfortex.com

Or ship a CD containing your graphics to:
Custom Graphics
Comfortex Window Fashions
21 Elm Street
Maplewood, NY 12189

Graphic File Specifications

Preferred Formats:

- Adobe Illustrator
- EPS

Other Accepted Formats:

- TIFF
- JPEG
- PSD

- All typography should be converted to paths when submitting an Illustrator or EPS file.
- TIFF and JPEG files should be submitted at the largest size possible, 300 DPI is preferred. We will size your graphics according to your shade size and specifications.
- Contact Comfortex Customer Care at 800-843-4151 with all questions regarding Custom Graphic Orders.
- Comfortex will not print any copyrighted custom graphics without appropriate permission.

Step 4. The Custom Graphic Team will email a PDF proof of your shade order for you to approve. Once the artwork is approved, it will take two weeks for your order to be printed, assembled, and shipped.

Custom Graphic Shades

CELLULAR SHADE FEATURES & GENERAL INFORMATION

How to order Custom Graphic Shades

STEP 1. FAX OR E-MAIL YOUR ORDER

Fax the appropriate Custom Graphics Cellular order form located on comfortex.com/comfortex-dealers to (800) 336-4580. Or e-mail the order form to customercare@comfortex.com. Upon receipt and review of your order, you will receive a work order confirmation number from Comfortex. Please be sure to reference this number when submitting your artwork in Step 2.

STEP 2. SOURCE AND SEND YOUR GRAPHIC

Source your graphic from a stock photo site such as www.istockphoto.com or use your own high resolution photography. Send your files via e-mail to: customgraphics@comfortex.com OR ship a CD/portable media containing your graphics to:

Custom Graphics
Comfortex Window Fashions
21 Elm Street
Maplewood, New York 12189

Using Online Stock Agencies for Graphics for Your Shades

Sometimes, finding the right graphic or photograph to fit your shade size, shape, or content can be challenging. Fortunately, many web sites offer a great solution. Online stock agencies allow you to purchase reasonably priced, royalty-free digital illustrations, graphics, photographs, patterns, and more in thousands of different subject areas. Some of the more popular sites include:

- thinkstock.com
- istockphoto.com
- veer.com
- shutterstock.com
- gettyimages.com
- 123rf.com
- photosearch.com

Using these sites is easy, simply follow these steps:

Step 1. Create an account and search for your image (i.e. apples).

Step 2. Select, purchase, and download the image you like. You may be given a choice of sizes, so take care to select an option large enough for your needs. Be sure to include the Work Order Confirmation Number received from Comfortex Customer Service with your graphic files.

STEP 3. APPROVE YOUR PROOF

The Custom Graphic Team will email a PDF proof of your shade order which must be reviewed and approved for production to begin. Once the artwork is approved, it will take 2 weeks for your order to be printed, assembled, and shipped.

Graphic File Specifications

Preferred Formats

- Vector files/Adobe Illustrator (AI or EPS)
Please convert all typography to paths prior to submitting your vector artwork.
- TIFF, JPG/JPEG, or Adobe Photoshop (PSD) files with a minimum resolution of 100 pixels per inch at 100% size. For example, a shade measuring 30" x 40" should be supported by a graphic measuring at least 3000 x 4000 pixels.
- Adobe Acrobat (PDF) files created in "Press Quality" or "High Quality Print" with a minimum resolution for all raster elements of 100 pixels per inch at 100% size.

Graphics optimized for, or harvested from the internet are, in general, not suitable for reproduction onto shades.

Comfortex will seek to verify ownership and rights to reprint for all images showcasing copyrighted material.

Questions? Please contact Comfortex Customer Care with all questions regarding Custom Graphic Orders.



EZ Level



Making A Template



Measuring



Child Safety



Cleaning & Care



Cellular Shade Collection

GENERAL INFORMATION

Scotchgard™ and Certified Fabrics

Scotchgard Protection

Scotchgard™ Protector is available with all cellular Shades. Scotchgard™ keeps your shades looking newer, fresher and cleaner longer.



A combination of the latest advances in stain release and repellency provides exceptional stain protection. Spills wipe away easily and most dirt and stains lift out when cleaned. Both sides of the fabric are treated with Scotchgard.

GREENGUARD Certified Fabrics

GREENGUARD Indoor Air Quality Certified® Fabrics
The GREENGUARD Environmental Institute has established performance based standards to define goods with low chemical and particle emissions for use indoors.

The following fabrics have the passed GREENGUARD Indoor Air Quality Certified® certification program for low emitting interior building materials, furnishings, and finish systems:

- Symphony (All)
- Baritone (All)
- Natural Linen Flax
- Virtuoso (All)
- Premiere (All)
- Debut (All)
- Linen Weave

The following fabrics have the passed GREENGUARD Children & SchoolsSM product certification program for low emitting interior building materials, furnishings, and finish systems used in educational (day care and K-12) environments:

- Symphony Light Filtering
- Symphony Blackout

Symphony Flame Resistant Fabrics

Symphony Flame Resistant Fabrics have been registered as a Flame Resistant Products by the California State Fire Marshall for products identified in section 13115, California Health and Safety Code (California CHSC). Copies of the certificates are located on the Comfortex.com/comfortex-dealers web site or on the On Demand Mobile library.

Color Selection

Use the current Cellular Shades Collection sample book to select colors from the Symphony light filtering fabric collection. All thirty colors are available in 3/8" Symphony light filtering double cell and 3/4" light filtering single cell.

Ordering Flame Resistant Shades

The SKU structure for Symphony Flame Resistant material is: 3012 05 XXX (XXX representing the color number).

To order Symphony Flame Resistant Shades: Use the SKU number listed on the decks.

The SKU structure for the 3/4" Symphony Flame Resistant material is: 2512 05 XXX

To order 3/4" Symphony Flame Resistant Shades:

Use the Symphony three digit color number to identify your desired color.

In this example:
2512 05 108



EZ Level on Comfortex Cellular Shades

EZ Level makes quick work of leveling without cords to cut or tuck into a rail. No special tools needed – just use a nickel, quarter or penny to adjust plug on the bottom rail.

EZ Level is standard on all Cellular and Pleated Shades with the following hardware systems:

- Standard and Deluxe Cord Lock
- Cordless Ultra
- Cord Loop
- SlumberShades
- Simplicity Motorized Systems

EZ Level is not available with Lift & Lock Cordless.

How does EZ Level work?

- Slightly raise the bottom rail you want to level.
- Insert a coin or flat head screwdriver into the adjustment screw and turn it.
- Turn the adjustment screw clockwise or counter clockwise to make slight adjustments up or down.



- One quarter turn of the adjustment screw will move the bottom rail up or down 1/4".
- Lower the rail to check the level and make further adjustments if necessary.

Cellular Shade Collection GENERAL INFORMATION

Cleaning and Care

While beautiful and pleasing to the eye, all Comfortex products are designed to be durable, easily cared for and easily cleaned. Our non-woven fabrics are inherently anti-static and repel dust, but occasional feather dusting or vacuuming may be necessary to keep the fabrics clean and bright. Comfortex Cellular fabrics may be ultrasonically cleaned.

Cleaning Symphony Blackout Fabrics: Our blackout fabrics are inherently anti-static and repel dust, but occasional cleaning may be necessary to keep the fabrics clean and bright. The fabric can be dusted with a soft, clean cloth, feather duster or lightly vacuumed with a soft brush attachment. To spot clean, use a cloth or sponge dipped in a light solution of lukewarm water and clear dish detergent and lightly dab. Do not scrub the surface. Rinse thoroughly.

Cleaning all other Comfortex Cellular Fabrics:

Our light filtering and room darkening fabrics are inherently anti-static and repel dust, but occasional cleaning may be necessary to keep the fabrics clean and bright. The fabric can be dusted with a soft, clean cloth, feather duster or lightly vacuumed with a soft brush attachment. Spills and stains can be lightly blotted with a cloth or damp sponge. More difficult stains may require soaking in water with mild soap. For this, remove the shades from the window and soak in warm water. Complete immersion of hardware is not recommended.

DO NOT submerge the Cordless Ultra head rail in water. When damp, lay flat to dry or place back in window and raise tightly to recrisp pleats. Please test any stronger cleaners on an unobtrusive portion of the shade before using.

For additional advice on care or cleaning, please contact our Technical Services Department.

Scotchgard™ Treated Shades

The following are the recommended cleaning and care instructions for window treatments with fabric treated with Scotchgard™ Protector.

- Gently blot liquid stains immediately with a clean, white cloth.
- If stain remains, prepare a solution of ¼ teaspoon of clear, non-bleaching dish detergent mixed with 1 cup of lukewarm water. Dampen a clean white cloth and gently blot the stain.
- Do not overwet the fabric or excessively rub the stained area.
- See the Installation and Care instructions for complete details.

For additional assistance with stain removal, call the Scotchgard™ Protector Service Center at 1-800-433-3296. Customer Care representatives are available Monday through Friday, 8am to 6pm CT.

Cut-Outs

Cut-outs are available with all cellular fabrics and are subject to approval by the Comfortex Technical Service department.

There are no limits on cut out lengths. There are limits on cut out widths:

Cellular shade widths 18" or less 3" maximum width
Cellular shade widths greater than 18" 5" maximum width

Cellular Shade Collection GENERAL INFORMATION

Cellular Shade MEASURING INSTRUCTIONS

Comfortex accepts measurements down to $\frac{1}{16}$ " increments.

Inside Mount

Use a steel tape to measure the opening at three different places, and use the narrowest dimension when ordering. Be exact! The factory will make the shade $\frac{3}{16}$ " narrower so it will not rub against the window casing. Measure the height of the window from the top (soffit) down to the sill.

Outside or Ceiling Mount

Use a steel tape to measure the exact height and width of the area to be covered. It is recommended that the shades overlap the window by at least $1\frac{1}{2}$ " on each side. When installation has no sill, allow the shade to overlap the bottom of the window casing by at least $1\frac{1}{2}$ ". Shade fabric will measure width indicated on the order form.

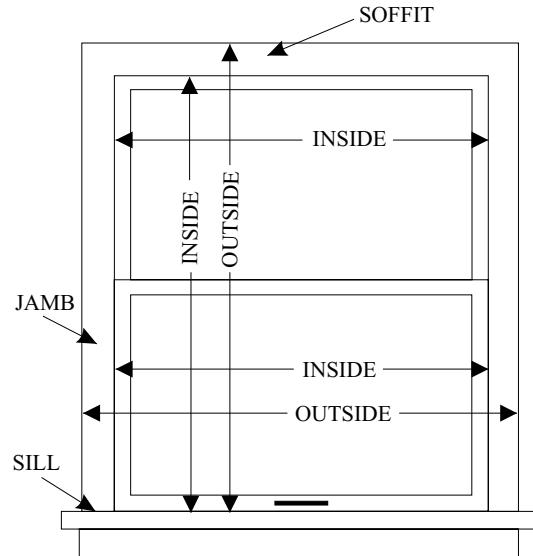

Measuring for Specialty Shapes

Templates are required with some specialty shade orders. Consult the individual product sections of this guide for specifics regarding accurate measurements and mounting information.

Arches and Quarter Round Circles

- Measure the window height and width appropriately for an inside or outside mount.
- With perfect arches, the height will be one half the width. With perfect quarter rounds, height will equal width. If the arch or quarter round is perfect, **a template is not required.**
- Windows with imperfect arch measurements do not maintain the height/width relationship. Templates **are required** for these windows.

Trapezoids

- Measure the window height and width appropriately for an inside or outside mount. For outside mounts, remember to add the desired amount of overlap.
- Measure all four sides for accurate fabrication. Provide all measurements. **Templates are not required.**
- The slope angle must be measured with a protractor. Slope is the angle between slope and a horizontal line. The maximum slope is 30 degrees.

Octagons

- Measure the window height and width appropriately for an inside or outside mount. Be sure to measure the width at the shade's widest point.
- Provide the width, length and the length of one side when ordering.

Cellular Shade Collection

GENERAL INFORMATION

Making the Perfect Template

Tape brown craft paper over the window opening. Be sure to allow plenty of overlap and check to see that the paper is smooth and pulled taut. Do not use newspaper as the ink can rub off on fabric. Do not use paper that has been folded. Notice the outline of the framework superimposed on the template as the light filters through the window. You may create the template in one of two ways:

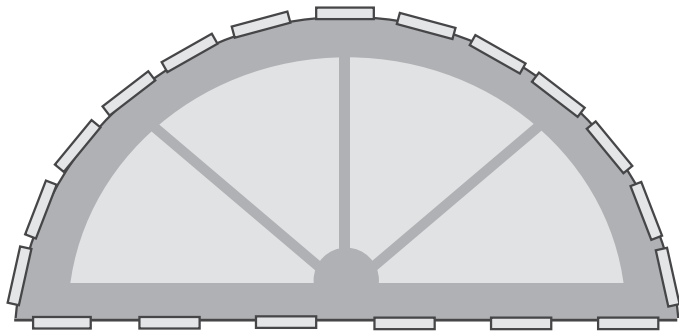

Trace the outline of the window with a pencil and continue along the side of the window frame. Once the window is completely traced, remove the craft paper from the window. Cut out the traced shape with a pair of scissors.

You may choose to skip tracing the window outline with a pencil and cut out the shape immediately with a razor knife.

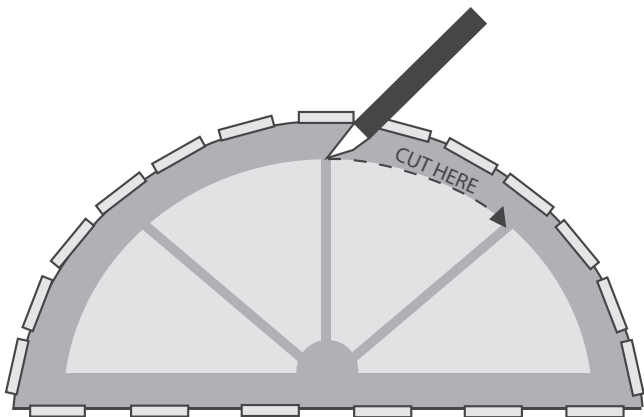

Once your template is cut, double check its width and height with your initial measurements. Test the template by placing it in the window. Check for light gaps, uneven cutting of curves etc. Trim or remake if necessary.

With arch top shades, fold the template in half. Check the outline of the curve for smoothness, light gaps and curve continuity. Place the template in the window and check it for light gaps or uneven cutting of curve. Trim or remake it if necessary.

On the front of the template, mark the shade measurements along with your company name, account number, sidemark, shade style and color. Be sure to indicate inside or outside mount, the room side and which ends of the template are top and bottom. Do not take any deductions on inside mount shades. The factory will make all necessary allowances for inside mounts.

Remember: The quality of the finished shades depends heavily on the quality of the template supplied. Do not hesitate to remake a template if you feel uncomfortable of the quality of your first attempt.

Template Kits: Comfortex offers template kits which includes brown craft paper, razor knife, instructions and order form. Please contact Customer Service or visit www.comfortex.com to order. Stock number: 751000

Cut-Outs

Cut-outs are available with all cellular fabrics.

Cut-outs are \$69.00 per side and are subject to approval by the Comfortex Technical Service department.

There are no limits on cut out lengths.

There are limits on cut out widths.

Cellular shade widths 18" or less: maximum 3" width cut-out

Cellular shade widths greater than 18": maximum 5" width cut-out

Cellular Shade Collection GENERAL INFORMATION

⚠️ WARNING

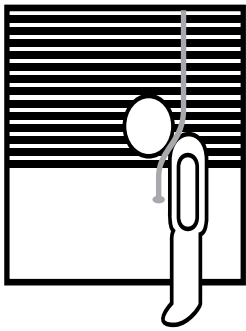

Window Blind Cord Can
STRANGLE Your Child.

To prevent strangulation, purchase
cordless products or products with
inaccessible cords.

⚠️ ADVERTENCIA

La cuerda ciega de la ventana
puede ESTRANGULAR su niño.

Para evitar el estrangulamiento,
compre alternativas inalámbricas o
productos con cables inaccesibles.

Child Safety

Comfortex has a long history of designing new child-safety products and is proud to provide a leadership role in cooperating with the Consumer Product Safety Commission (CPSC) for the development of policies and guidelines for the industry by serving on the WCMA Standards Development Committee.

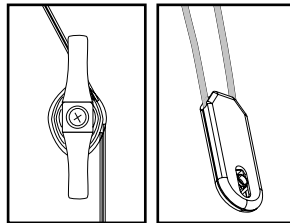

Cord Cleat

Cord
Tensioner

All Comfortex products have been fully tested and proven to comply with the current WCMA Standards for safety of corded window coverings.

Be aware that it is possible for children to become entangled in window covering cords. To reduce the risk of accidents, all cords must be kept out of the reach of children.

A cord cleat or cord tensioner is an effective way to implement this essential precaution. Please use them.

To mount the cord cleat at a safe height, take into account furniture or other objects upon which a child may climb. Then, after the use of the blind, simply wrap the excess cord around the cleat.

COMFORTEX CELLULAR SHADES

	Page
Hardware Options	1
Size Standards	4
Hardware Option Availability	12
Hardware Upgrade Options.	15
 PRICE GRIDS	
Standard Rectangular - Cord Lock Cordless Lift & Lock	Price Group 1-8. 18
SlumberShade.	Price Group 9 25
Ovation Cellular Slider.	Price Group 10-11. 26
Starburst Arches	
Quarter Rounds.	Price Group 12-13. 28
Sunset Movable Arches.	Price Group 14-15. 30
Trapezoids and Octagons	Price Group 16-17. 32
Soprano Skylights	Price Group 18-19. 34
Balcony Skylight Shadings	Price Group 20-21. 35
Mezz Motorized Skylights	Price Group 22-23. 37
Non-Movable French Door Decor - Light Filtering.	Price Group 24 39
Movable French Door Decor - Light Filtering.	Price Group 25 40
Non-Movable French Door Decor - Room Darkening	Price Group 26 41
Movable French Door Decor - Room Darkening	Price Group 27 42
 HARDWARE	
Standard Cord Lock.	44
Cord Loop	46
Cordless Ultra	48
Cordless Lift & Lock.	50
12V Non-Rechargeable Simplicity Motorization	52
7.4V Rechargeable Simplicity Motorization.	54
7.4V Rechargeable Motorized Top Down-Bottom Up	57
7.4V EZ Charge Extension Wand	59
12V Simplicity Low Voltage Hardwiring System	60
Simplicity Smart Controller	61
7.4V Rechargeable PowerTouch Motorization	62
Ovation Cellular Slider.	64
Insulating Slumbershades	66
Starburst Arches	68
Sunset Arches	69
Quarter Rounds.	71
Trapezoids and Octagons	73
Soprano Skylights and Greenhouse Shades	75
Balcony Shadings	77

COMFORTEX CELLULAR SHADES- CONTINUED	Page
7.4V Mezzo Rechargeable Motorized Skylight	79
French Door Decor	82
Day-Night Shades	84
Custom Graphic Shades	86
 GENERAL INFORMATION	
EZ Level	91
Cleaning and Care.	92
Measuring	93
Making A Template	94
Child Safety	95



Midwest
Designer
Supply

1-888-523-2611

**Midwest Designer Supply, Inc.
N30W22377 Green Road Ste C
Waukesha, WI 53186
(262) 523-2600
Fax (262) 524-1007
www.midwestdesignersupply.com**

MDS - your one source for window fashions.